



Trimble R12

GNSS RECEIVER

USER GUIDE

Version 1
Revision A
November 2019

Corporate Office

Trimble Inc.
935 Stewart Drive
Sunnyvale, California 94085
USA

Geospatial Division

Trimble Inc.
10368 Westmoor Drive
Westminster, CO 80021
USA

www.trimble.com

Email: trimble_support@trimble.com

Legal Notices

© 2019, Trimble Inc. All rights reserved.

Trimble, the Globe & Triangle logo, CenterPoint, OmniSTAR, and xFill are trademarks of Trimble Inc., registered in the United States and in other countries. CMR+, EVEREST, ProPoint, RTX, SurePoint, Trimble Access, TRIMMARK, VRS and VRS Now are trademarks of Trimble Inc.

Microsoft, Edge, Internet Explorer, Silverlight, and Windows are either registered trademarks or trademarks of Microsoft Corporation in the United States and/or other countries.

The Bluetooth word mark and logos are owned by the Bluetooth SIG, Inc. and any use of such marks by Trimble Inc. is under license.

Wi-Fi is a registered trademark of the Wi-Fi Alliance.

Apple, iPad, and iPhone are trademarks of Apple Inc., registered in the U.S. and other countries.

Use of the Made for Apple badge means that an accessory has been designed to connect specifically to the Apple product(s) identified in the badge and has been certified by the developer to meet Apple performance standards. Apple is not responsible for the operation of this device or its compliance with safety and regulatory standards.



Google, Google Play and other marks are trademarks of Google LLC.



All other trademarks are the property of their respective owners.

Support for Galileo is developed under a license of the European Union and the European Space Agency.

NTP Software Copyright

© University of Delaware 1992-2015. Permission to use, copy, modify, and distribute this software and its documentation for any purpose with or without fee is hereby granted, provided that the above copyright notice appears in all copies and that

both the copyright notice and this permission notice appear in supporting documentation, and that the name University of Delaware not be used in advertising or publicity pertaining to distribution of the software without specific, written prior permission. The University of Delaware makes no representations about the suitability of this software for any purpose. It is provided "as is" without express or implied warranty.

Release Notice

This is the November 2019 release (Revision A) of the Trimble R12 receiver documentation.

Limited Warranty Terms and Conditions

Product Limited Warranty

Subject to the terms and conditions set forth herein, Trimble Inc. ("Trimble") warrants that for a period of 1 year from date of purchase this Trimble product (the "Product") will substantially conform to Trimble's publicly available specifications for the Product and that the hardware and any storage media components of the Product will be substantially free from defects in materials and workmanship.

Product Software

Product software, whether built into hardware circuitry as firmware, provided as a standalone computer software product, embedded in flash memory, or stored on magnetic or other media, is licensed solely for use with or as an integral part of the Product and is not sold. The terms of the end user license agreement, as included below, govern the use of the Product Software, including any differing limited warranty terms, exclusions and limitations, which shall control over the terms and conditions set forth in the limited Product warranty.

Warranty Remedies

If the Trimble Product fails during the warranty period for reasons covered by this limited warranty and you notify Trimble of such failure during the warranty period, Trimble will repair OR replace the nonconforming Product with new, equivalent to new, or reconditioned parts or Product, OR refund the Product purchase price paid by you, at Trimble's option, upon your return of the Product in accordance with Trimble's product return procedures then in effect.

How to Obtain Warranty Service

To obtain warranty service for the Product, please contact your Trimble dealer. Alternatively, you may contact Trimble to request warranty service at +1-408-481-6940 (24 hours a day) or email your request to trimble_support@trimble.com. Please be prepared to provide:

- your name, address, and telephone numbers;
- proof of purchase;
- a copy of this Trimble warranty

- a description of the nonconforming Product including the model number; and
- an explanation of the problem.

The customer service representative may need additional information from you depending on the nature of the problem.

Warranty Exclusions and Disclaimer

This Product limited warranty shall only apply in the event and to the extent that (i) the Product is properly and correctly installed, configured, interfaced, maintained, stored, and operated in accordance with Trimble's applicable operator's manual and specifications, and; (ii) the Product is not modified or misused. This Product limited warranty shall not apply to, and Trimble shall not be responsible for, defects or performance problems resulting from (i) the combination or utilization of the Product with hardware or software products, information, data, systems, interfaces, or devices not made, supplied, or specified by Trimble; (ii) the operation of the Product under any specification other than, or in addition to, Trimble's standard specifications for its products; (iii) the unauthorized installation, modification, or use of the Product; (iv) damage caused by: accident, lightning or other electrical discharge, fresh or salt water immersion or spray (outside of Product specifications); or exposure to environmental conditions for which the Product is not intended; (v) normal wear and tear on consumable parts (e.g., batteries); or (vi) cosmetic damage. Trimble does not warrant or guarantee the results obtained through the use of the Product or Software, or that software components will operate error free.

NOTICE REGARDING PRODUCTS EQUIPPED WITH TECHNOLOGY CAPABLE OF TRACKING SATELLITE SIGNALS FROM SATELLITE BASED AUGMENTATION SYSTEMS (SBAS) (WAAS, EGNOS, AND MSAS), OMNISTAR, GPS, MODERNIZED GPS OR GLONASS SATELLITES, OR FROM IALA BEACON SOURCES: TRIMBLE IS NOT RESPONSIBLE FOR THE OPERATION OR FAILURE OF OPERATION OF ANY SATELLITE BASED POSITIONING SYSTEM OR THE AVAILABILITY OF ANY SATELLITE BASED POSITIONING SIGNALS.

THE FOREGOING LIMITED WARRANTY TERMS STATE TRIMBLE'S ENTIRE LIABILITY, AND YOUR EXCLUSIVE REMEDIES, RELATING TO THE TRIMBLE PRODUCT. EXCEPT AS OTHERWISE EXPRESSLY PROVIDED HEREIN, THE PRODUCT, AND ACCOMPANYING DOCUMENTATION AND MATERIALS ARE PROVIDED "AS-IS" AND WITHOUT EXPRESS OR IMPLIED WARRANTY OF ANY KIND, BY EITHER TRIMBLE OR ANYONE WHO HAS BEEN INVOLVED IN ITS CREATION, PRODUCTION, INSTALLATION, OR DISTRIBUTION, INCLUDING, BUT NOT LIMITED TO, THE IMPLIED WARRANTIES OF MERCHANTABILITY AND FITNESS FOR A PARTICULAR PURPOSE, TITLE, AND NON-INFRINGEMENT. THE STATED EXPRESS WARRANTIES ARE IN LIEU OF ALL

OBLIGATIONS OR LIABILITIES ON THE PART OF TRIMBLE ARISING OUT OF, OR IN CONNECTION WITH, ANY PRODUCT. BECAUSE SOME STATES AND JURISDICTIONS DO NOT ALLOW LIMITATIONS ON DURATION OR THE EXCLUSION OF AN IMPLIED WARRANTY, THE ABOVE LIMITATION MAY NOT APPLY TO YOU.

Limitation of Liability

TRIMBLE'S ENTIRE LIABILITY UNDER ANY PROVISION HEREIN SHALL BE LIMITED TO THE AMOUNT PAID BY YOU FOR THE PRODUCT. TO THE MAXIMUM EXTENT PERMITTED BY APPLICABLE LAW, IN NO EVENT SHALL TRIMBLE OR ITS SUPPLIERS BE LIABLE FOR ANY INDIRECT, SPECIAL, INCIDENTAL, OR CONSEQUENTIAL DAMAGE WHATSOEVER UNDER ANY CIRCUMSTANCE OR LEGAL THEORY RELATING IN ANYWAY TO THE PRODUCTS, SOFTWARE AND ACCOMPANYING DOCUMENTATION AND MATERIALS, (INCLUDING, WITHOUT LIMITATION, DAMAGES FOR LOSS OF BUSINESS PROFITS, BUSINESS INTERRUPTION, LOSS OF DATA, OR ANY OTHER PECUNIARY LOSS), REGARDLESS OF WHETHER TRIMBLE HAS BEEN ADVISED OF THE POSSIBILITY OF ANY SUCH LOSS AND REGARDLESS OF THE COURSE OF DEALING WHICH DEVELOPS OR HAS DEVELOPED BETWEEN YOU AND TRIMBLE. BECAUSE SOME STATES AND JURISDICTIONS DO NOT ALLOW THE EXCLUSION OR LIMITATION OF LIABILITY FOR CONSEQUENTIAL OR INCIDENTAL DAMAGES, THE ABOVE LIMITATION MAY NOT APPLY TO YOU.

PLEASE NOTE: THE ABOVE TRIMBLE LIMITED WARRANTY PROVISIONS WILL NOT APPLY TO PRODUCTS PURCHASED IN THOSE JURISDICTIONS (E.G., MEMBER STATES OF THE EUROPEAN ECONOMIC AREA) IN WHICH PRODUCT WARRANTIES ARE THE RESPONSIBILITY OF THE LOCAL DEALER FROM WHOM THE PRODUCTS ARE ACQUIRED. IN SUCH A CASE, PLEASE CONTACT YOUR TRIMBLE DEALER FOR APPLICABLE WARRANTY INFORMATION.

Notices

USA

Class B Statement – Notice to Users. This equipment has been tested and found to comply with the limits for a Class B digital device, pursuant to Part 15 of the FCC rules and Part 90. These limits are designed to provide reasonable protection against harmful interference in a residential installation. This equipment generates, uses, and can radiate radio frequency energy and, if not installed and used in accordance with the instructions, may cause harmful interference to radio communication. However, there is no guarantee that interference will not occur in a particular installation. If this equipment does cause harmful interference to radio or television reception, which can be determined by turning the equipment off and on, the user is encouraged to try to correct the interference by one or more

of the following measures:

- Reorient or relocate the receiving antenna.
- Increase the separation between the equipment and the receiver.
- Connect the equipment into an outlet on a circuit different from that to which the receiver is connected.
- Consult the dealer or an experienced radio/TV technician for help.

Changes and modifications not expressly approved by the manufacturer or registrant of this equipment can void your authority to operate this equipment under Federal Communications Commission rules.

Unlicensed radios in products

This device complies with part 15 of the FCC Rules.

Operation is subject to the following two conditions:

- (1) This device may not cause harmful interference, and
- (2) This device must accept any interference received, including interference that may cause undesired operation.

Licensed radios in products

This device complies with part 15 of the FCC Rules.

Operation is subject to the condition that this device may not cause harmful interference.

Canada

This Class B digital apparatus complies with Canadian ICES-003.

Cet appareil numérique de la classe B est conforme à la norme NMB-003 du Canada.

This apparatus complies with Canadian RSS-GEN, RSS-310, RSS-210, and RSS-119.

Cet appareil est conforme à la norme CNR-GEN, CNR-310, CNR-210, et CNR-119 du Canada.

European Union

The products covered by this guide may be operated in all EU member countries (BE, BG, CZ, DK, DE, EE, IE, EL, ES, FR, HR, IT, CY, LV, LT, LU, HU, MT, NL, AT, PL, PT, RO, SI, SK, FI, SE, UK), Norway and Switzerland. Products been tested and found to comply with the requirements for a Class B device pursuant to European Council Directive 89/336/EEC on EMC, thereby satisfying the requirements for CE Marking and sale within the European Economic Area (EEA). Contains a Bluetooth, WWAN 802.11 b/g/n, 3G radio module. These requirements are designed to provide reasonable protection against harmful interference when the equipment is operated in a residential or commercial environment. The 450 MHz (PMR) bands and 2.4 GHz are non-harmonized throughout Europe.

EU Declaration of Conformity

Hereby, Trimble Inc., declares that this receiver is in compliance with the essential requirements and other relevant provisions of Directive 2014/53/EU.

Trimble Inc. vakuuttaa täten että vastaanotin tyyppinen laite on direktiivin 2014/53/EU oleellisten vaatimusten ja sitä koskevien direktiivin muiden ehtojen mukainen.

Hierbij verklaart Trimble Inc. dat het toestel ontvanger in overeenstemming is met de essentiële eisen en de andere relevante bepalingen van richtlijn 2014/53/EU.

Bij deze verklaart Trimble Inc. dat deze ontvanger voldoet aan de essentiële eisen en aan de overige relevante bepalingen van Richtlijn 2014/53/EU.

Par la présente Trimble Inc. déclare que l'appareil récepteur est conforme aux exigences essentielles et aux autres dispositions pertinentes de la directive 2014/53/EU.

Härmed intygar Trimble Inc. att denna mottagare står i överensstämmelse med de väsentliga egenskapskrav och övriga relevanta bestämmelser som framgår av direktiv 2014/53/EU.

Undertegnede Trimble Inc. erklærer herved, at følgende udstyr modtager overholder de væsentlige krav og øvrige relevante krav i direktiv 2014/53/EU.

Hiermit erklärt Trimble Inc., dass empfangen in Übereinstimmung mit den grundlegenden Anforderungen und den anderen relevanten Vorschriften der Richtlinie 2014/53/EU befindet.

ΜΕ ΤΗΝ ΠΑΡΟΥΣΑ Trimble Inc ΔΗΛΩΝΕΙ ΟΤΙ Δέκτης ΣΥΜΜΟΡΦΩΝΕΤΑΙ ΠΡΟΣ ΤΙΣ ΟΥΣΙΩΔΕΙΣ ΑΠΑΙΤΗΣΕΙΣ ΚΑΙ ΤΙΣ ΛΟΙΠΕΣ ΣΧΕΤΙΚΕΣ ΔΙΑΤΑΞΕΙΣ ΤΗΣ ΟΔΗΓΙΑΣ 2014/53/EU.

Con la presente Trimble Inc. dichiara che questo ricevitore è conforme ai requisiti essenziali ed alle altre disposizioni pertinenti stabilite dalla direttiva 2014/53/EU.

Por medio de la presente Trimble Inc. declara que el receptor cumple con los requisitos esenciales y cualesquiera otras disposiciones aplicables o exigibles de la Directiva 2014/53/EU.

Trimble Inc. declara que este receptor está conforme com os requisitos essenciais e outras disposições da Directiva 2014/53/EU.

Australia and New Zealand

This product conforms with the regulatory requirements of the Australian Communications and Media Authority (ACMA) EMC framework, thus satisfying the requirements for RCM marking and sale within Australia and New Zealand.



Restriction of Use of Certain Hazardous Substances in Electrical and Electronic Equipment (RoHS)

Trimble products in this guide comply in all material respects with DIRECTIVE 2011/65/EU OF THE EUROPEAN PARLIAMENT AND OF THE COUNCIL of 21 July 2011 on the restriction of the use of certain hazardous substances in electrical and electronic equipment (RoHS Directive) and with exemptions for lead in solder pursuant to Paragraph 7 of the Annex to the RoHS Directive applied.

Taiwan

經型式認證合格之低功率射頻電機，非經許可，公司、商號或使用者均不得擅自變更頻率、加大功率或變更原設計之特性及功能。

低功率射頻電機之使用不得影響飛航安全及干擾合法通信；經發現有干擾現象時，應立即停用，並改善至無干擾時方得繼續使用。

前項合法通信，指依電信法規定作業之無線電通信。

低功率射頻電機須忍受合法通信或工業、科學及醫療用電波輻射性電機設備之干擾。

The product contains a removable Lithium-ion battery. Taiwanese regulations require that waste batteries are recycled.

廢電池請回收

Waste Electrical and Electronic Equipment (WEEE)

For product recycling instructions and more information, please go to www.trimble.com/ev.shtml.





Recycling in Europe: To recycle Trimble WEEE (Waste Electrical and Electronic Equipment, products that run on electrical power.), Call +31 497 53 24 30, and ask for the “WEEE Associate”. Or, mail a request for recycling instructions to:

Trimble Europe BV
c/o Menlo Worldwide Logistics
Meerheide 45
5521 DZ Eersel, NL

Safety Information

Before you use your Trimble product, make sure that you have read and understood all safety requirements.

 **WARNING** – This alert warns of a potential hazard which, if not avoided, could result in severe injury or even death.

 **CAUTION** – This alert warns of a potential hazard or unsafe practice that could result in minor injury or property damage or irretrievable data loss.

***NOTE** – An absence of specific alerts does not mean that there are no safety risks involved.*

Use and care

This product is designed to withstand the rough treatment and tough environment that typically occurs in construction applications. However, the receiver is a high-precision electronic instrument and should be treated with reasonable care.

 **CAUTION** – Operating or storing the receiver outside the specified temperature range can damage it.

Exposure to radio frequency radiation

For 450 MHz radio

Safety. Exposure to RF energy is an important safety consideration. The FCC has adopted a safety standard for human exposure to radio frequency electromagnetic energy emitted by FCC regulated equipment as a result of its actions in General Docket 79-144 on March 13, 1986.

Proper use of this radio modem results in exposure below government limits. The following precautions are recommended:

- **DO NOT** operate the transmitter when someone is within the following distances of the antenna:
 - Bluetooth, Wi-Fi, GSM/UTMS – less than 20 cm (7.9 inches)
 - 410-470 MHz UHF radio – less than 47 cm (18.5 inches)

- **DO NOT** operate the transmitter unless all RF connectors are secure and any open connectors are properly terminated.
- **DO NOT** operate the equipment near electrical blasting caps or in an explosive atmosphere.
- All equipment must be properly grounded according to Trimble installation instructions for safe operation.
- All equipment should be serviced only by a qualified technician.

For internal wireless radio transmitters

The radiated output power of the internal Bluetooth wireless radio and the Wi-Fi radio included in some Trimble receivers is far below the FCC radio frequency exposure limits. Nevertheless, the wireless radio(s) shall be used in such a manner that the Trimble receiver is 20 cm or further from the human body. The internal wireless radio(s) operate within guidelines found in radio frequency safety standards and recommendations, which reflect the consensus of the scientific community. Trimble therefore believes that the internal wireless radio(s) are safe for use by consumers. The level of energy emitted is far less than the electromagnetic energy emitted by wireless devices such as mobile phones. However, the use of wireless radios may be restricted in some situations or environments, such as on aircraft. If you are unsure of restrictions, you are encouraged to ask for authorization before turning on the wireless radio.

Exposure to radio frequency radiation from cellular wireless transmitters

Trimble receivers equipped with wireless cellular modem radios have been designed and manufactured to meet safety requirements for limiting exposure to radio waves. When used in accordance with the instructions set forth in this manual, the equipment has been independently verified to not exceed the emission limits for safe exposure to radio frequency (RF) energy as specified by the Federal Communications Commission of the U.S. Government in 47 CFR §2.1093. These limits are part of comprehensive guidelines and establish permitted levels of RF energy for the general population. The guidelines are based on standards that were developed by independent scientific organization through periodic and thorough evaluation of scientific studies. The standards include a substantial safety margin designed to assure the safety of all persons, regardless of age and health.

For UMTS radio

Safety. Exposure to RF energy is an important safety consideration. The FCC has adopted a safety standard for human exposure to radio frequency electromagnetic energy emitted by FCC regulated equipment as a result of its actions in General Docket 79-144 on March 13, 1986.

Proper use of this radio modem results in exposure below government limits. The following precautions are recommended:

- **DO NOT** operate the transmitter when someone is within 20 cm (7.9 inches) of the antenna.
- All equipment should be serviced only by a qualified technician.

Installing antennas

 **CAUTION** – For your own safety, and in terms of the RF exposure requirements of the FCC, always observe these precautions:

- Always maintain a minimum separation distance of 24 cm (9.5 inches) between yourself and the radiating antenna.
 - Do not co-locate the antenna with any other transmitting device.
-

 **WARNING** – The GNSS receiver and its cabling should be installed in accordance with all national and local electrical codes, regulations, and practices. The receiver and cabling should be installed where they will not become energized as a result of falling nearby power lines, nor be mounted where they are subjected to over-voltage transients, particularly lightning. Such installations require additional protective means that are detailed in national and local electrical codes.

Trimble receiver internal radios have been designed to operate with the antennas listed below. Antennas not included in this list are strictly prohibited for use with this device. The required antenna impedance is 50 ohms.

Trimble-approved antennas that can be used (country dependent) are:

- **450 MHz radio** – 0 dBi and 5 dBi whip antennas

To reduce potential radio interference to other users, the antenna type and its gain should be an approved Trimble antenna, so that the equivalent isotropically radiated power (e.i.r.p.) is not more than that permitted for successful communication.

Type approval

Type approval, or acceptance, covers technical parameters of the equipment related to emissions that can cause interference. Type approval is granted to the manufacturer of the transmission equipment, independent from the operation or licensing of the units. Some countries have unique technical requirements for operation in particular radio-modem frequency bands. To comply with those requirements, Trimble may have modified your equipment to be granted type approval.

Unauthorized modification of the units voids the type approval, the warranty, and the operational license of the equipment.

Contents

Safety Information	6
Use and care	6
Exposure to radio frequency radiation	6
For internal wireless radio transmitters	7
Exposure to radio frequency radiation from cellular wireless transmitters	7
For UMTS radio	7
Installing antennas	8
Type approval	8
1 Introduction	14
Overview	14
R12 GNSS receiver features	15
Related information	16
Technical support	16
2 Setting up the receiver	17
Parts of the receiver	17
Front panel	17
Lower housing	18
Receiver ports	18
Batteries	19
Battery safety	19
Connecting the receiver to a vehicle battery	20
Wet locations	21
Charging the Lithium-ion battery	21
Storing the Lithium-ion battery	21
Disposing of the rechargeable Lithium-ion battery	22
Using the battery charger	22
Charging the battery	24
Inserting the battery and SIM card	26
Accessories	27
Attaching the quick release adapter	27
Base station extension with measurement lever	27
Height measurement methods	30
3 Configuring and using the receiver	31
Button and LED operations	32

Power button	32
Satellite LED	33
Radio LED	34
Wi-Fi LED	34
Data logging/downloading LED	34
LED flash patterns	35
Connecting to an office computer	36
Connecting to a USB flash memory stick	36
Configuring a PC USB port as a virtual serial port	37
Windows 8 operating system	37
Windows 7 Professional operating system	38
Windows 7 operating system	38
Configuring the receiver using Wi-Fi and the Web Interface	39
Connecting via Wi-Fi	39
Web interface menus	42
Menu overview	43
Upgrading the receiver firmware	45
Configuring the internal transceiver	45
Adding and removing receive-only frequencies for the 450 MHz internal radio using the web interface	46
Configuring the receiver using Trimble software and Bluetooth wireless technology	47
Configuring the receiver using the GNSS Status utility	49
Using Location Services	50
Logging data	50
Logging data after a power loss	51
Transferring files directly from the receiver	51
Deleting files in the receiver	51
4 Default Settings	52
Default receiver settings	52
Resetting the receiver to factory defaults	53
5 Base Station Operation	54
Base station operation guidelines	54
Base station components	54
Base station setup guidelines	55
Common ways to set up a base station	57
Tripod and tribrach setup	58
Fixed height tripod setup	58
Using a remote radio antenna with the receiver	60

Using an external radio with the receiver	61
Outputting corrections using a TDL450/HPB450 radio-modem	61
6 Rover Setup and Operation	62
Rover operation guidelines	62
Connecting the receiver to external devices	64
Connecting to a Trimble controller running Trimble Access software	64
Internal radio-modems	65
External radio-modems	65
Integrated cellular modem	66
SurePoint (advanced sensors)	66
Calibrating the integrated tilt sensor and magnetometer	66
7 Trimble Installation Manager	70
Trimble Installation Manager functions and features	70
Installing Trimble Installation Manager	71
Upgrading the receiver firmware	71
Download Trimble Survey GNSS Firmware to a local machine using Trimble Installation Manager	71
Updating the radio frequency list	72
8 Troubleshooting	73
Troubleshooting receiver issues	73
Troubleshooting LED conditions	74
Troubleshooting base station setup and static measurement problems	75
9 Output Messages	77
NMEA-0183 messages: Overview	78
NMEA-0183 messages: Common message elements	80
NMEA Message values	80
RTCM Output: Generated messages	81
GSOF Messages: Overview	82
GSOF messages: General Serial Output Format	83
GSOF messages: Reading binary values (Motorola format)	85
10 Specifications	87
Performance specifications	88
Positioning performance	89
Hardware	91
Antenna phase center offsets	94

Pinout information	95
Glossary	96

Introduction

- [Overview](#)
- [R12 GNSS receiver features](#)
- [Related information](#)
- [Technical support](#)

This manual describes how to set up and use a Trimble® R12 GNSS receiver.

Even if you have used other Global Navigation Satellite System (GNSS) products before, Trimble recommends that you spend some time reading this manual to learn about the special features of your receiver.

If you are not familiar with GNSS, visit our website for an interactive look at Trimble and GNSS at www.trimble.com.

Overview

The Trimble R12 GNSS receiver incorporates a GNSS antenna, receiver, Bluetooth® wireless technology, Wi-Fi, an optional internal 450 MHz radio with receive and transmit options, and a battery in a rugged light-weight unit that is ideally suited as an all-on-the-pole RTK rover or quick setup/rapid mobilization base station.

LEDs enable you to monitor satellite tracking, radio reception, data logging status, Wi-Fi status, and power. Bluetooth wireless technology provides cable-free communications between the receiver and controller.

You can use the receiver as part of an RTK GNSS system with the Trimble Access™ software. The receiver can optionally record GNSS data to the receiver's internal memory and download to a computer or USB flash memory stick.



The receiver has no front panel controls for changing settings. To configure the receiver, use the web interface which is available by connecting to the receiver's Wi-Fi via a PC or a smartphone.

R12 GNSS receiver features

The R12 GNSS receiver has the following features:

- Measure points in challenging GNSS environments with greater accuracy, reliability, and productivity than ever before with Trimble ProPoint™ GNSS technology
- Small, lightweight design – 1.12 kg (2.49 lb) (integrated radio, GNSS receiver, GNSS antenna and battery); 3.95 kg (8.71 lb) complete system weight (rover including TSC7 controller and rod)
- 672-channel, Trimble 360 receiver, fully future-proof signal tracking of current GNSS systems:
 - GPS: L1C/A, L1C, L2C, L2E, L5
 - GLONASS: L1C/A, L1P, L2C/A, L2P, L3
 - SBAS: L1C/A, L5
 - Galileo: E1, E5A, E5B, E5 AltBOC, E6¹
 - BeiDou: B1, B1C, B2, B2A, , B3
 - QZSS: L1C/A, L1S, L1C, L2C, L5, L6
 - NavIC (IRNSS): L5
- Increased productivity and measurement traceability with SurePoint™ tilt compensation technology
- Capable of using Trimble CenterPoint® RTX corrections delivered via satellite or IP
- Reduced downtime due to loss of radio or cellular signal with Trimble xFill® technology
- Capable of tracking all OmniSTAR® signals
- Internal, removable, smart Lithium-ion battery provides up to 6+ hrs GNSS rover operation per battery
- Bluetooth wireless technology for cable free, no hassle, base or rover operation
- Integrated Wi-Fi
- Simple keypad with on/off key and LED indicators for power, radio, Wi-Fi, and satellite tracking
- 20 Hz update rate

- Full base/rover interoperability
- Operates within a Trimble VRS Now™ network for conventional base station-free rover capability
- Fully integrated 3.5G UMTS cellular modem²
- Integrated receive and transmit radio (optional)
- Capable of tracking all SBAS systems (WAAS/EGNOS/MSAS/GAGAN)

¹The current capability in the receivers is based on publicly available information. As such, Trimble cannot guarantee that these receivers will be fully compatible with a future generation of Galileo satellites or signals.

²Due to local regulations, the integrated cellular modem cannot be enabled in China, Taiwan, or Brazil. A Trimble controller integrated cellular modem or external cellular modem can be used to obtain GNSS corrections via an IP (Internet Protocol) connection.

Related information

Sources of related information include the following:

- Release notes – The release notes describe new features of the product, information not included in the manuals, and any changes to the manuals. They can be downloaded from the Trimble website at www.trimble.com/Support/Support_AZ.aspx.
- Trimble training courses – Consider a training course to help you use your GNSS system to its fullest potential. For more information, go to the Trimble website at www.trimble.com/Support/Index_Training.aspx.

Technical support

If you have a problem and cannot find the information you need in the product documentation, contact your local dealer. Alternatively, go to the Support area of the Trimble website (www.trimble.com/Support/Index_Support.aspx). Select the product you need information on. Product updates, documentation, and any support issues are available for download.

Setting up the receiver

- [Parts of the receiver](#)
- [Batteries](#)
- [Using the battery charger](#)
- [Charging the battery](#)
- [Inserting the battery and SIM card](#)
- [Accessories](#)

Parts of the receiver

All operating controls are located on the front panel. Serial ports and connectors are located on the bottom of the unit.

Front panel

The following figure shows a front view of the receiver. The front panel contains the four indicator LEDs and the Power button with LED.



The **Power** button controls the receiver's power on or off functions.

The indicator LEDs show the status of data logging/downloading, power, satellite tracking, Bluetooth/Wi-Fi, and radio transmit/receive.

For more information, see [Button and LED operations, page 32](#).

Lower housing

The lower housing contains the two communication and power ports, one SMA radio antenna connector, and the Quick Release Socket.



- 1 SMA Connection: UHF antenna
- 2 Quick Release socket
- 3 Lemo Port 1: Serial connection
- 4 Lemo Port 2: USB connection

Receiver ports

Icon	Name	Connections
	Port 1	Device, computer, external radio, power in, power out
	Port 2	Device, computer, USB flash memory stick, power in
	RADIO	Radio communications antenna

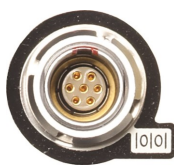

Port 1 is a 7-pin 0-shell Lemo connector that supports RS-232 communications and external power input. Port 1 has no power outputs.



Port 2 is a 7-pin 0-shell Lemo connector that allows for USB 2.0 communications and external power input. For more information, see [Default receiver settings, page 52](#).



The SMA port connector is for connecting a radio antenna to the receiver internal radio. A whip “rubber duck” antenna is supplied with the system for units with internal UHF radios. This connector is not used if you are using an external UHF radio. For longer range operation (to provide higher gain and to raise the antenna higher above the ground), you can use a cable to connect an external radio antenna to the SMA port. For more information, refer to the "Connecting the receiver to external devices" topic in the Web Help.

Batteries

The receiver has one rechargeable Lithium-ion battery, which can be removed for charging. You can also connect the receiver to an external power source through Port 1 or Port 2.

During measurement operations, the internal battery typically provides about 6.5 hours of power if using the internal Rx (receive) radio and about 6 hours operating as a base station using the internal 450 MHz Tx (transmit at 0.5 watt) radio. These times vary according to the type of measurement and the operating conditions.

Battery safety

Charge and use the battery only in strict accordance with the instructions provided.

 **WARNING** – Do not damage the rechargeable Lithium-ion battery. A damaged battery can cause an explosion or fire, and can result in personal injury and/or property damage.

To prevent injury or damage:

- Do not use or charge the battery if it appears to be damaged. Signs of damage include, but are not limited to, discoloration, warping, and leaking battery fluid.
- Do not expose the battery to fire, high temperature, or direct sunlight.
- Do not immerse the battery in water.
- Do not use or store the battery inside a vehicle during hot weather.
- Do not drop or puncture the battery.
- Do not open the battery or short-circuit its contacts.

 **WARNING** – Avoid contact with the rechargeable Lithium-ion battery if it appears to be leaking. Battery fluid is corrosive, and contact with it can result in personal injury and/or property damage.

To prevent injury or damage:

- If the battery leaks, avoid contact with the battery fluid.
- If battery fluid gets into your eyes, immediately rinse your eyes with clean water and seek medical attention. Do not rub your eyes!
- If battery fluid gets onto your skin or clothing, immediately use clean water to wash off the battery fluid.

Connecting the receiver to a vehicle battery

 **WARNING** – Use caution when connecting battery cable's clip leads to a vehicle battery. Do not allow any metal object or jewelry to connect (short) the battery's positive (+) terminal to either the negative (-) terminal or the metal of the vehicle connected to the battery. This could result in high current, arcing, and high temperatures, exposing the user to possible injury.

 **WARNING** – When connecting an external battery, such as a vehicle battery, to the receiver, be sure to use the Trimble cable with proper over-current protection intended for this purpose, to avoid a safety hazard to the user or damage to the product.

Wet locations

 **WARNING** – This product is not intended to be used outdoors or in a wet location when it is powered by the external power supply. The connection is not waterproof and could be subject to electrical shorting.

 **WARNING** – The external power adapter and its associated power cord and plug are not intended to be installed outdoors, or in a wet location.

Charging the Lithium-ion battery

The rechargeable Lithium-ion battery is supplied partially charged. Charge the battery completely before using it for the first time. Charging takes approximately 3 hours per battery at room temperature. If the battery has been stored for longer than three months, charge it before use.

 **WARNING** – Charge and use the rechargeable Lithium-ion battery only in strict accordance with the instructions. Charging or using the battery in unauthorized equipment can cause an explosion or fire, and can result in personal injury and/or equipment damage. To prevent injury or damage:

- Do not charge or use the battery if it appears to be damaged or leaking.
 - Charge the Lithium-ion batteries only in a Trimble battery charger, such as the dual battery charger P/N 109000 or P/N 53018010. Be sure to follow all instructions that are provided with the battery charger.
 - Discontinue charging a battery that gives off extreme heat or a burning odor.
 - Use the battery only in Trimble equipment that is specified to use it.
 - Use the battery only for its intended use and according to the instructions in the product documentation.
-

To charge the battery, first remove the battery from the receiver, and then place it in the battery charger, which is connected to AC power.

Storing the Lithium-ion battery

Do not store batteries in the receiver or in the external charger unless power is applied.

Keep all batteries on continuous charge when not in use. You can keep batteries on charge indefinitely without damage to the batteries.

Disposing of the rechargeable Lithium-ion battery

Discharge a Lithium-ion battery before disposing of it. Dispose of batteries in an environmentally sensitive manner, and adhere to any local and national regulations concerning battery disposal or recycling.

Using the battery charger

The charger can charge three types of Lithium-ion batteries. It can be powered by AC power or vehicle battery.



The dual slot charger consists of:

- Charger dual-battery slot (P/N 109000)
- Power supply for charger (P/N 107000)
- Power cord (6 ft). Different cords with appropriate plugs for different countries are supplied with the power supply.
- Charger battery slot insert (P/N 109001-00)

Chargeable batteries

The charge can charge the following types of batteries:

- P/N 76767 Lithium-ion Rechargeable Battery (Smart Battery). Requires a plastic adapter insert to fit into the charger
- P/N 99511-30 Lithium-ion Rechargeable Battery (Smart Battery). Remove battery slot inserts to charge this type of battery.
- P/N 92670 Lithium-ion Rechargeable Battery. Remove battery slot inserts to charge this type of battery.

Charger slots

The charger has two slots. Each slot can charge one of the three supported battery types. Batteries are charged concurrently for P/N 92670 and P/N 76767 battery types and sequentially for the P/N 99511-30 battery type. Beside each slot are three LED indicators (red, yellow, and green) to indicate the battery and charging / conditioning status

Power supply

The charger can be powered by AC power (using the power supply for the charger) or by car voltage using a 12V vehicle adapter for dual battery charger (P/N P/N 108090, not included with receiver kit).

AC power supply is an external adapter, usable worldwide. Different cords with appropriate plugs for different countries are supplied with adapter.

Vehicle power

The charger can be powered by vehicle voltage of nominal 12 V. It can withstand voltages of a vehicle voltage of nominal 24 V (maximum 32 V). So if the user connects the vehicle cable by mistake to a 24 V socket in a vehicle the charger does not start charging but latches in fault condition and flashes all green LEDs. The power must be removed to reset the fault condition.

Charger technical data

DC Power Input Voltage limits	10V to 32V
Absolute maximum input voltage	32V
Over voltage	21V to 32V
Working voltage	10V to 21V
Under voltage	<10V
Charging (19V in, 25°C, 10% to 90% charge)	
• 92670 Battery	<3 Hr
• 76767 Battery	<3 Hr
• 99511-30 Battery	<4 Hr
Charging (12V in, 25°C, 10% to 90% charge)	
• 92670 Battery	<3 Hr
• 76767 Battery	<3 Hr
• 99511-30 Battery	<6 Hr

Charging the battery

 **CAUTION** – Ensure that nothing obstructs the vents in the back of the charger.

The battery is supplied partially charged. Charge the battery completely before using it for the first time.

- To charge the battery, use only a charger that Trimble recommends for charging the Lithium-ion battery.
- Charge the battery before using the equipment if it has been stored for longer than six months.

The charger operates between 0 °C (32 °F) and 40 °C (104 °F). Charging a battery at temperatures in the range of 0 °C (32 °F) to 5 °C (41 °F) will take longer than charging at room temperature.

To charge the battery:

1. Ensure that the vents in the back of the charger are unobstructed.
2. Place the charger on a hard, flat and level surface, to ensure that there is airflow around the charger.
3. To apply power to the charger, use the AC to DC converter or 12 V vehicle adapter. The red LEDs light up with no batteries inserted in the battery slots. The charger automatically scans the battery slots for a battery.
4. Place the battery in any of the slots. The red light turns off (can take up to 5s). For an explanation of the LEDs, see [LED status indicators](#) below.
5. Charging takes approximately 3 hours per GNSS receiver battery (P/N 76767) at room temperature. If two batteries are charging in the battery charger, the batteries will be charged simultaneously.

Leave a deeply discharged or shorted battery overnight in the charger to attempt to revive the battery. A shorted battery is typically revived as soon as the slot is scanned. If the red LED turns off, the battery is revived. If the red LED stays on, the battery is no longer functional and needs to be replaced.

LED status indicators

Beside each slot are three LED indicators (red, green, and yellow) to display the battery status. The LED indicators can have the following conditions: Off, On, 1 Hz (one flash per second), and 2 Hz (two flashes per second):

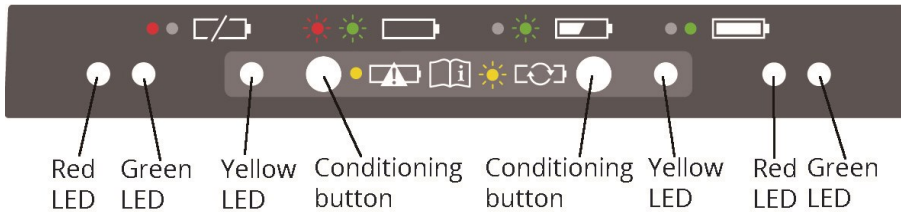

Status	Red LED	Green LED	Yellow LED
No battery detected (means no battery present or battery defect)	ON	OFF	OFF
Battery detected (charging not started yet)			
• Conditioning not required	1 Hz	1 Hz	OFF
• Conditioning required	1 Hz	1 Hz	ON
Charging in progress			
• Conditioning not required	OFF	1 Hz	OFF
• Conditioning required	OFF	1 Hz	ON
• Over/under-temperature (charge is inhibited)	2 Hz	OFF	OFF
Conditioning in progress	ON	OFF	1 Hz
Conditioning done (Charging after 30% battery capacity)	ON	1 Hz	OFF
Conditioning done (Battery fully charged)	ON	ON	OFF
Battery fully charged			
• Conditioning not required	OFF	ON	OFF
• Conditioning required	OFF	ON	ON
Power supply over/under-voltage	OFF	OFF	OFF
When Output Over-Voltage Protection (OOVP) or Output Over Current Protection (OCP) is on	2 Hz	OFF	OFF

Troubleshooting and corrective measures

Battery is not detected (Does not change from only red LED on after battery insertion).

Issue	Solution
The battery is not properly inserted.	Properly insert battery into battery charger slot.
Battery contacts contaminated.	Clean the battery (for example, by inserting and removing the battery several times) or replace the battery.
Deeply discharged or shorted battery.	Leave the battery overnight in the charger to attempt to revive the battery.
Battery defective.	Replace the battery.
LED abnormalities occurring.	Remove any batteries from both slots and disconnect the AC adapter from the charger.

Inserting the battery and SIM card

Align the arrows and on the battery and battery compartment and then insert the battery as indicated in the images below.

To remove the battery, slide the battery bail to the left.



NOTE – The gasket on the inside of the battery door should be clean of any dirt or dust to ensure proper sealing of the battery compartment.

Insert the SIM card with the contacts facing upward, as indicated by the SIM card icon next to the SIM card slot.

To eject the SIM card, slightly push it in to trigger the spring-loaded release mechanism.

NOTE – The SIM card is provided by your cellular network service provider.



Accessories

Attaching the quick release adapter

Push down the spring-loaded button of the quick release adapter and then align the white dots on the bottom of the receiver and the quick release adapter. Slide in the quick release adapter and then release the button.



Base station extension with measurement lever

The Trimble R12 GNSS receiver uses a base station extension pole that increases the height of the receiver to allow clearance for the 450 MHz internal radio antenna and also allows for easy and accurate measurement of the base station antenna height. The extension pole includes a height measurement lever with a defined measurement point:



To measure the height of the base station extension with measurement lever, measure the slant height from the control point on the ground to the height measurement point on the

lever. Enter the slant height into the field software (or web interface) and then select the **Lever of R10 extension** measurement method. The field software (or web interface) automatically calculates the antenna height from the slant height. The base station extension with measurement lever should be used when setting up a base station or static session on an extension leg tripod with tribrach.

The illustration below shows the Trimble R12 GNSS receiver with base station extension with measurement lever (P/N 89846-00):



The Base Station Extension with Measurement Lever is available as a standalone accessory (P/N 89846-00) or within the Base Kit or Post processed (PP) Kit.

NOTE – *Measuring to the measurement lever is not required when using a fixed height tripod. If the base station extension with measurement lever is used with a fixed height tripod, the height of the extension pole (0.15 m (0.49 ft)) should be added to the height of the fixed height tripod and the measurement method “bottom of quick release” used.*

Base Extension with Measurement Lever (P/N 89846-00):



Base Kit (P/N 89861-00):



PP Kit (P/N 89862-00):



Height measurement methods

The following antenna height measurement methods are available in the field/office software and web interface:



- ❶ Bottom of antenna mount
- ❷ Bottom of quick release
- ❸ Lever of R10 extension

Configuring and using the receiver

- Button and LED operations
- LED flash patterns
- Connecting to an office computer
- Configuring a PC USB port as a virtual serial port
- Configuring the receiver using Wi-Fi and the Web Interface
 - Upgrading the receiver firmware
 - Configuring the internal transceiver
 - Adding and removing receive-only frequencies for the 450 MHz internal radio using the web interface
- Configuring the receiver using Trimble software and Bluetooth wireless technology
- Configuring the receiver using the GNSS Status utility
- Logging data
- Transferring files directly from the receiver
- Deleting files in the receiver

You can configure the receiver in a number of ways. These topics describe the different configuration methods, and explain when and why each method is used.

The [Trimble Access Help portal](#) is likely to be your main tool to set up and operate the receiver on a daily basis. All required field configurations are handled through the Trimble Access software running on a Trimble TSC7 controller, T10 tablet, or T7 tablet. For more information, refer to the [Trimble Access Help portal](#).

Button and LED operations



The LEDs on the front panel indicate various operating conditions. Generally, a lit or slowly flashing LED indicates normal operation, a LED that is flashing quickly indicates a condition that may require attention, and an unlit LED indicates that no operation is occurring. The following table defines each possible LED state:

The term...	means that the LED...
Very slow flash	is off and on equally with a 1.5 second cycle.
Slow flash	alternates on/off every ½ second.
Radio slow flash	is <i>off longer than it is on</i> when the receiver is <i>receiving corrections</i> . The receiver repeats this cycle typically once per second. is <i>on more than off</i> when the receiver is <i>transmitting corrections</i> . The receiver repeats this cycle typically once per second.
Medium flash	is off and on equally more than once per second.
Fast flash	alternates rapidly on/off every 1/10 of a second.
On	is lit steady.
Off	is unlit.



Power button

Action	Power button	Description
Turn on the receiver	Press (see the note below)	All four LEDs light up and remain lit for 3 seconds. Then all LEDs go off and then the power LED immediately comes back on.
Turn off the receiver	Hold for 2 seconds and then release	When holding down the Power button; the battery LED remains on. The Satellite LED turns constant and then turns off after 2 seconds. After releasing the power button, the battery LED stays lit

Action	Power button	Description
		for about 5 seconds and then all LEDs go blank.
Clear the ephemeris file and reset the receiver to the factory defaults	Hold for 15 seconds	The Radio, Wi-Fi, and Satellite LEDs turn off after 2 seconds. The battery LED remains on. After 15 seconds, the Satellite LED comes on to indicate that it is time to release the Power button. Upon restart, the Wi-Fi will also turn on in Access Point mode.
Delete application files and data logging files	Hold for 30 seconds	The Radio, Wi-Fi, and Satellite LEDs turn off after 2 seconds. After 15 seconds, the Satellite LED comes on and stays on for 15 seconds, then turns off to indicate that it is time to release the Power button. The receiver then restarts.

NOTE – The term “press” means to press the button and release it immediately. The term “hold” means to press the button and hold it down for the given time.



Satellite LED

Receiver mode	Satellite LED Amber
No satellites tracked	Off
Boot up or when in Monitor mode	On
Tracking fewer than 4 SVs	Fast flash
Tracking 4 or more SVs	Slow flash

Radio LED

Radio mode	Radio LED Amber	Description
No receive or transmit	Off	
Receive	Radio slow flash	See the table at the top of this topic. This LED also flashes when using the Wi-Fi only for receiving corrections.
Transmit	Radio slow flash	See the table at the top of this topic. This LED also flashes when using the Wi-Fi only for transmitting corrections.

Wi-Fi LED

Receiver mode	Wi-Fi LED Amber
Wi-Fi off	Off
Wi-Fi is access point (base mode/sending corrections)	Medium flash
Wi-Fi is client (and not connected to an access point)	Off
Wi-Fi as client (rover mode receiving corrections)	Very slow flash

Data logging/downloading LED

Receiver mode	Data LED Amber
Data logging off	Off
Data logging on	On
Downloading to USB flash memory stick	Slow flash
Full USB flash memory stick detected	Fast flash
Download to USB flash memory stick complete	Very slow flash

LED flash patterns

The following table details the possible flash patterns to indicate various states of receiver operation.

Receiver mode	Power button	Radio LED	Satellite LED	Data LED	Wi-Fi LED
Receiver OFF	OFF	OFF	OFF	OFF	OFF
Receiver ON, healthy power	ON	N/A	N/A	N/A	N/A
Low power	Fast flash	N/A	N/A	N/A	N/A
Transmitting correction messages	N/A	Flashes off when transmitting	N/A	N/A	N/A
Receiving valid data packets	N/A	Slow flash	N/A	N/A	N/A
Tracking fewer than 4 SVs	ON	N/A	Fast flash	N/A	N/A
Tracking 4 or more SVs	ON	N/A	Slow flash	N/A	N/A
Logging data internally	N/A	N/A	N/A	Solid	N/A
Transferring data to flash memory stick	N/A	N/A	N/A	Slow flash	N/A
All data transferred to flash memory stick	N/A	N/A	N/A	Very slow flash	N/A
Flash memory stick full	N/A	N/A	N/A	Fast flash	N/A
Wi-Fi configured as an access point	N/A	N/A	N/A	N/A	Slow flash
Wi-Fi configured as a client	N/A	N/A	N/A	N/A	On
Receiver in monitor mode (loading firmware from WinFlash)	ON	Slow flash	Solid	OFF	OFF

NOTE – If a column shows “N/A”, that specific LED may or may not be on, but it is not relevant to that particular mode.

Connecting to an office computer

The receiver can communicate with the office computer using a serial connection by either using a serial cable (P/N 89851-00 or P/N 59046), or by using the USB cable (P/N 89852-00 or P/N 80751) and then [Configuring a PC USB port as a virtual serial port, page 37](#). Before you connect to the office computer, ensure that the receiver battery is fully charged.

The following figure shows how to connect to the computer for serial data transfer:

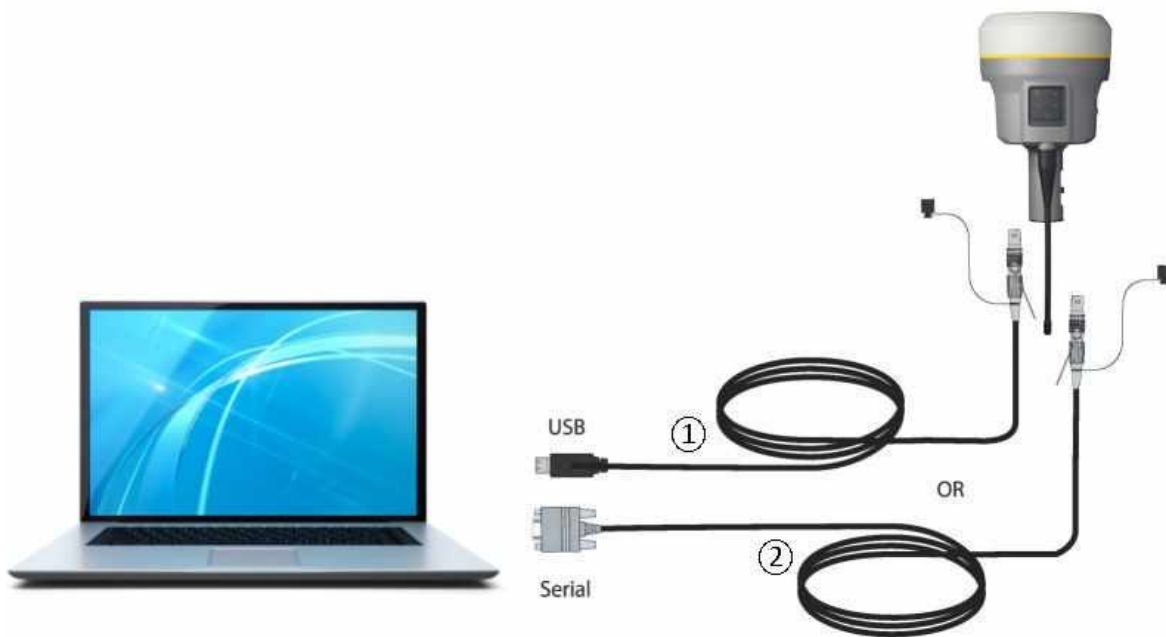

- 1 USB cable (P/N 89852-00 or 80751)
- 2 Serial cable (P/N 89851-00 or P/N 59046)

Connecting to a USB flash memory stick

The receiver can download logged data directly to a USB flash memory stick using the supplied USB field data cable (P/N 80799 or 89850-00). After the cable is connected to the receiver's port 2 (USB) and the flash memory stick attached, the receiver will download all logged files to the flash memory stick.

NOTE – The USB field data cable is used to download logged (existing) data files from the receiver memory to the flash memory stick. The USB field data cable cannot be used to log data files directly to the flash memory stick.

The following figure shows a flash memory stick connected to the receiver using the USB download cable:



Configuring a PC USB port as a virtual serial port

It is possible to use the USB interface from a Trimble R12 receiver with a software application that requires a serial port.

For example, the Trimble Installation Manager can be run on a computer that has no physical serial port by connecting the USB cable between the computer and the receiver.

NOTE – This step is not necessary for Windows 10, or if you have previously installed the Trimble USB driver.

Windows 8 operating system

1. The simplest way to install the virtual serial port for the USB interface to the receiver is to go to the Trimble Support website (http://www.trimble.com/Support/Support_AZ.aspx) and search for the GNSS receiver you have. In the **Technical Support / Downloads** section, download the file called *Windows7 USB Installer* to your computer.

NOTE – There is no *Windows8 USB Installer* file; the *Windows7 USB Installer* file works for Windows 8.

This file contains a Support Note and installation program.

2. Run the installation program. It will load the virtual serial port for the USB interface on your computer .

***NOTE** – With Windows 8, the USB ports are often version 3.0. With Windows 8 there is a conflict with the implementation of USB version 3.0. To workaround this, go to the computer's BIOS settings when you start up the computer and then turn off the support for USB 3.0.*

Windows 7 Professional operating system

1. The simplest way to install the virtual serial port for the USB interface to the receiver is to go to the Trimble Support website (www.trimble.com/support) and search for the receiver you have. In the Downloads section, download the file called *Windows7 USB Installer* to your computer.

This file contains a Support Note and installation program.

2. Run the installation program. It will load the virtual serial port for the USB interface on your computer.

If this process does not work for your computer, or if you have a different Windows operating system on your computer, then follow the procedure below.

Windows 7 operating system

1. Go to the Trimble Support website (www.trimble.com/support) and search for the receiver you have. In the Support Notes section, download the file called *R10 GNSS Interface to a Virtual COM port on a Computer* to your computer.
2. Open the file and place the trmbUsb.inf file in a temporary folder on your computer.
3. On the computer, select **Control Panel / Device Manager**.
4. Click on the name of the computer and then from the **Action** menu, select **Add Legacy Driver**.
5. A wizard prompts you to locate the TrimbleUsb.inf file. Locate the file and then follow the prompts in the wizard to continue.

***NOTE** – If you are running an application such as WinFlash software or Trimble Installation Manager on the computer and you physically disconnect the USB cable from the computer and then reconnect it, it does not always re-establish the connection. This is because opening the serial port from the application locks the device handle and when the USB device is disconnected, the application does not close the serial port and the device handle is still locked. On reconnecting, the USB cable is unable to get the device handle since it is locked. You must close the application before the reconnect to the port will work. This limitation is due to the behavior of the Microsoft USB serial driver.*

Configuring the receiver using Wi-Fi and the Web Interface

The receiver has a Wi-Fi port so that the receiver can connect directly to a PC or smartphone (access point mode) or to a wireless network (client mode). You can use Wi-Fi to access, configure, and monitor the receiver. No cable connection to the receiver is required.

Connecting via Wi-Fi

The receiver is set to access point by default. In access point mode, you can connect directly to the receiver from a PC or smartphone.

1. Using the Wi-Fi connection application on your PC or smartphone, find the access point SSID for the receiver. Turn on the Trimble GNSS receiver and wait for the words "Trimble GNSS" and last four digits of the receiver serial number to appear in your Wi-Fi connection application. For example, Trimble GNSS xxxx (where xxxx represents the last four digits of the receiver serial number).
2. Connect to the receiver. By default, all encryption is turned off in the receiver.
3. Open your web browser and then type the receiver IP address into the **URL** field. By default the IP address of the receiver is **http://192.168.142.1**.
4. The first time you launch the web interface, you will be required to set up a new password for the 'admin' login. You will initially see that the list of menu options is limited to **Security and Firmware**.

When prompted, enter the default login username and password. By default, the login is **admin** and the password is **password**. However, if initializing the admin password outside of a WAN/LAN connection, i.e. over the Internet, the default password is the receiver serial number.

You will be prompted to enter a new password. Use a combination of upper and lowercase letters, numbers, and punctuation to obtain a 'medium' or 'strong' password; a 'weak' password will be rejected.

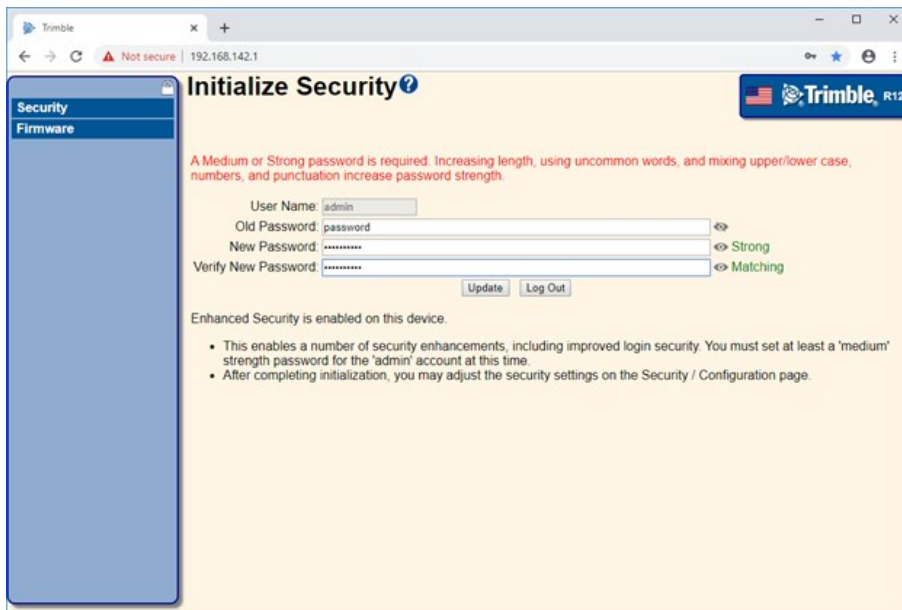

***NOTE** – If the ‘admin’ user password is lost, you can reset the receiver to factory defaults to reset the password; press-hold the physical power button on the receiver for 30 seconds to reset the receiver.*

Next, you will be prompted to configure security for the receiver’s Wi-Fi access point (optional).

By default, the encryption type is “Open”, i.e. no encryption. You can select an encryption option from the list and provide a security key, or else leave the encryption open.

You also have the option to not broadcast the SSID (the Wi-Fi network name), which will prevent other devices from detecting your receiver’s Wi-Fi access point.

When you are satisfied with your Wi-Fi access point security configuration, click **Save**.

5. The receiver web interface is displayed and the receiver is ready for real-time configuration.

The web page on the smartphone mini-browser opens with a select number of menus. To view the Full (Classic) menu, use the **Show Classic Web GUI** link in the heading area. To return to the mini-browser, the Wi-Fi connection or receiver must be reset (that is, turned on or off).

For more information, search for the topic "Web Interface Menus" in the Trimble R12 GNSS Receiver WebHelp.

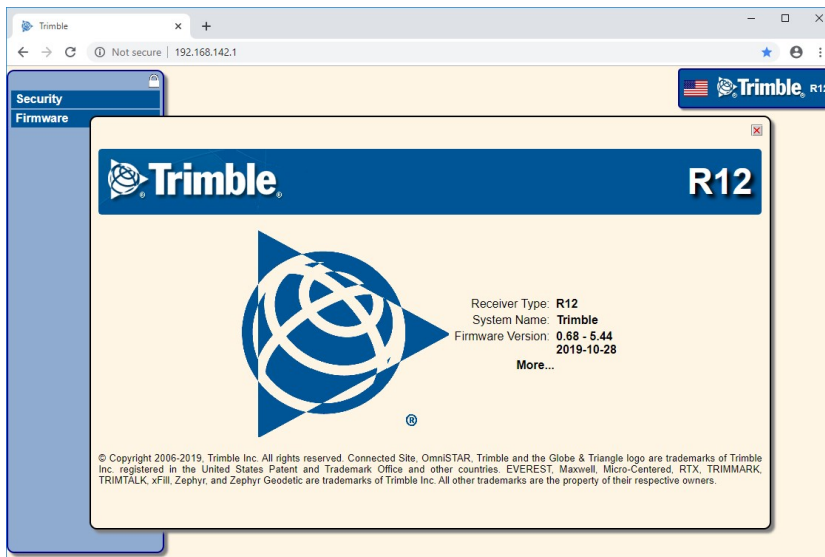

Default Wi-Fi connection settings

Out of the box, the receiver is configured to default settings for Wi-Fi connections. You can change any of these settings as required.

The default settings are:

- Wi-Fi mode: access point
- Wi-Fi SSID: Trimble GNSS xxxx (where xxxx represents the last four digits of the receiver serial number)
- Wi-Fi Encryption: Off
- Wi-Fi IP Address: 192.168.142.1
- Receiver Login: admin
- Receiver Password: password

Web interface menus

Use the web interface to configure the receiver settings.

Supported languages

The web interface is available in the following languages:

- English (en)
- Chinese (zh)
- Dutch (nl)
- Finnish (fi)
- French (fr)
- German (de)
- Italian (it)
- Japanese (ja)
- Norwegian (n)
- Polish (pl)
- Portuguese (pt)
- Russian (ru)
- Spanish (es)
- Swedish (sv)

Use the **Receiver Configuration / Default Language** setting to select the default language for your use.

The web interface shows the configuration menus on the left of the browser window, and the settings on the right. Each configuration menu contains related submenus to configure the receiver and monitor receiver performance.

Supported browsers

For PCs and laptops, current versions of these HTML browsers are supported:

- Google Chrome (recommended)
- Mozilla Firefox
- Microsoft Internet Explorer for Windows operating systems
- Opera
- Apple Safari
- Microsoft Edge[®]

To access the web interface on a Trimble R12 GNSS receiver using a tablet or a smartphone with the Wi-Fi link to the Trimble R12 GNSS receiver, Trimble recommends:

- Google Chrome for Android devices
- Apple Safari for iOS devices

Menu overview

The following configuration menus are available.

Receiver Status menu

The **Receiver Status** menu provides a quick link to review the receiver's available options, current firmware version, IP address, temperature, runtime, satellites tracked, current outputs, available memory, position information, and more.

Satellites menu

Use the **Satellites** menu to view satellite tracking details and enable/disable GNSS and SBAS satellites.

***NOTE** – To configure the receiver for Trimble CenterPoint RTX or OmniSTAR correction services, use the MSS Corrections menu.*

Data Logging menu

Use the **Data Logging** menu to set up the receiver to log static GNSS data. You can also configure settings such as observable rate, position rate, continuous logging, continuous logging rate, and whether to auto delete old files if memory is low.

Receiver Configuration menu

Use the **Receiver Configuration** menu to configure such settings as elevation mask and PDOP mask, the reference station position, and the reference station name and code.

I/O Configuration menu

Use the **I/O Configuration** menu to set up all outputs of the receiver. Depending on the receiver's specification it may output CMR, RTCM, RTCM-REPEAT, RT17/RT27, 1PPS, NMEA, or GSOF messages on a variety of ports including TCP/IP, NTRIP, UDP, serial or Bluetooth ports.

Bluetooth menu

Use the **Bluetooth** menu to configure the receiver to connect to other devices that use Bluetooth wireless technology. These devices can be used to configure the receiver, and generate or receive corrections.

The following Trimble and third party devices can be connected to the receiver using Bluetooth wireless technology:

- Trimble TSC7 controller
- Trimble T10 tablet
- Trimble T7 tablet
- Other Bluetooth-enabled devices
- Supported iOS and Android mobile devices

Radio menu

The Trimble R12 receiver can include an internal UHF radio.

Use the **Radio** menu to configure the internal UHF radio of the receiver, if applicable. The receivers are available with 410 MHz to 470 MHz radios.

If the receiver does not have an internal radio installed, the **Radio** menu is not available.

GSM/GPRS modem menu

Use the **GSM/GPRS modem** menu to check the status and configure the internal UMTS modem. It includes information about the inserted SIM card.

MSS Corrections

The receiver can receive Trimble CenterPoint RTX and OmniSTAR corrections.

To receive CenterPoint RTX corrections, you must enable the receiver to track the RTX satellites and it must have a valid CenterPoint RTX subscription.

To obtain a CenterPoint RTX subscription or contact support, go to positioningservices.trimble.com.

For information on OmniSTAR services or to contact support, go to www.omnistar.com.

Network Configuration menu

Use the **Network Configuration** menu to configure Ethernet settings, email alerts, PPP connection, HTTP port, and FTP port settings of the receiver.

Wi-Fi

Use the **Wi-Fi** menu to configure the Wi-Fi access mode and access point, so that using a Wi-Fi enabled device such as a smartphone, you can access the web interface of a Trimble GNSS receiver.

Security menu

Use the **Security** menu to configure the login accounts for all users who will be permitted to configure the receiver using a web browser. Each account consists of a username, password, and permissions. Administrators can use this feature to limit access to other users.

Firmware menu

Use the **Firmware** menu to verify the current firmware and load new firmware to the receiver. You can upgrade firmware across a network or from a remote location without having to connect to the receiver with a serial cable.

Help menu

To access the Help, your computer must be connected to the Internet. If you do not have access to the Internet, there is also a copy of the receiver Help files on the support area of the Trimble website (http://www.trimble.com/support/index_support.aspx).

Upgrading the receiver firmware

You can use Wi-Fi to upgrade the firmware for your receiver using the web browser. Whenever Trimble releases new firmware your receiver will check and display the new firmware version number in the web browser. You can then decide to install the newer firmware from the web browser.

Configuring the internal transceiver

If your receiver has the optional internal radio installed, you can use the Web Interface to configure the internal transceiver.

1. Select **Radio / Radio Configuration**.
2. Under **Channel Bandwidth Management**, select either 12.5 kHz or 25 kHz channel spacing.
3. Under **General Configuration Management**:
 - a. Select the appropriate operating mode, depending on how you intend to use the receiver. For example, select **Transmit with no repeaters**.
 - b. Select the current channel. This determines the radio operating frequency.
 - c. Select the wireless mode, which determines the over-the-air communications parameters.

To reduce battery consumption on your base receiver, set the wireless mode as high as possible. For example, 9600 bps (bit per second) consumes half the power of 4800 bps for the same data format and time of operation.

NOTE – All radios in the network must be configured with the same wireless setting.

- d. For base modes only, select one of the following channel-sharing configurations (this is not available for rover modes):
 - **Off.** The carrier detect mode is off. The unit will ignore other transmissions on your frequency and transmit data.

NOTE – It may be illegal in your country of use to set channel sharing to off. You may be subject to penalties or fines based upon the specific licensing requirements of your country of use. Please consult your radio license documentation or licensing agency for operational guidelines.
 - **Avoid weak signal.** The carrier mode is on. The radio will cease transmitting if it detects another radio transmission on its frequency. It will resume transmission when the channel is free of radio traffic.
 - **Avoid strong signal.** The carrier detect mode is on, but the radio will stop transmitting only when there is a strong signal present (receive level greater than 90 dBm).
 - e. If you are operating in base mode, select the **Enable Call Sign** check box and then enter your call sign in the **Call Sign** field. This FCC requirement is for U.S. licensed users. It sets your radio to transmit your call sign in Morse code every 15 minutes.
 - f. Select either 0.5 Watt or 2 Watts **RF Power Level**.
4. To update the configuration, click **OK**.

Adding and removing receive-only frequencies for the 450 MHz internal radio using the web interface

If your receiver has the optional internal radio installed, you can use the web interface to add and manage receive-only 450 MHz frequencies.

1. Select **Radio/ Radio Configuration**.
2. Under **Receive-only Channel Management**:
 - a. The maximum number of frequencies is 20. Verify that the **Current Number Used** is less than 20 if you need to add frequencies, or else delete unneeded receive-only frequencies.
 - b. To add a receive-only channel, enter the frequency in the field next to the **Add Channel** button.

- c. The **Add Channel** radio button is selected by default. If you wish to remove a receive frequency, select the **Delete Channel** radio button and then select the channel to be deleted from the dropdown list.

3. Click **OK** to add or remove the required receive-only frequency.

***NOTE** – The frequencies that you program must conform to the channel spacing and minimum tuning requirements for the radio. This setting can be changed under Channel Bandwidth Management. You may select either 12.5 or 25 kHz channel spacing. All radios in your network must use the same channel spacing.*

***NOTE** – You can only configure receive frequencies. The FCC-approved transmit frequencies must be specified and configured by Trimble.*

Configuring the receiver using Trimble software and Bluetooth wireless technology

This topic describes how to connect to and configure the receiver using Trimble field software.

Step 1: Create a Bluetooth connection between the computer and the receiver

1. Launch **Bluetooth Settings**.

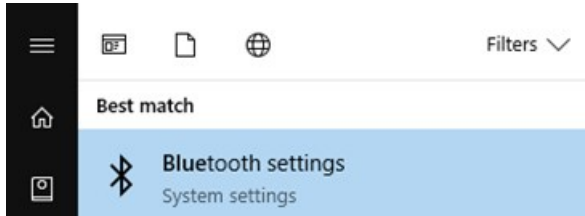

2. The computer searches for Bluetooth devices. Make sure that the receiver is on; it will appear in the list of Bluetooth devices. Select the receiver in the list and click **Pair**.

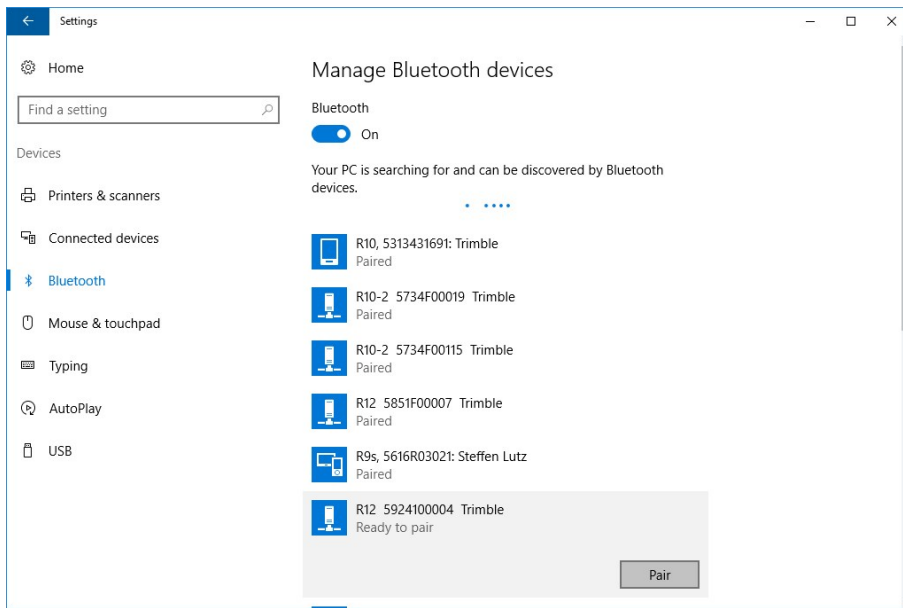

***NOTE** – When the receiver is powered on, a 5-minute pairing timer starts, during which time the Bluetooth module is discoverable by external devices. After the 5-minute countdown has elapsed, or after any device is paired with the receiver, the Bluetooth module is no longer discoverable by external devices. The pairing timer can be initiated manually from within the Bluetooth Configuration menu in the receiver Web User Interface by clicking **Start Now**. Alternatively, the timer can be reinitiated without accessing the receiver Web User Interface by power cycling the receiver.*

3. If prompted, enter the device's pairing code. By default, the pairing code is 0000.
4. When the device has been successfully paired, you can inspect its properties. Click the Bluetooth icon in the notification area (in the lower right corner of the Windows taskbar) and then select **Open Settings**.

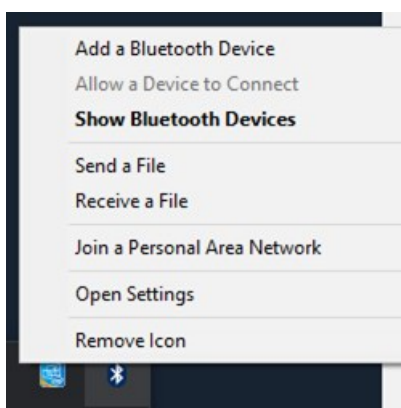

In the **Bluetooth Settings** window, select the device from the **Hardware** tab and then select **Properties**.

Step 2: Configure the receiver using Trimble software

Use Trimble software (for example, Trimble Access or Trimble TerraFlex software) to configure the receiver as required. For more information, refer to the user guide for the Trimble field software that you are using.

Configuring the receiver using the GNSS Status utility

To configure a receiver using the Trimble GNSS Status utility, you must pair the receiver with the device that is running the GNSS Status utility, and, on Android devices, you must enable Mock Locations.

You can connect a R12 GNSS receiver to a handheld device or tablet powered by the following operating systems:

- Android versions 5.0 and later
- iOS
- Windows® 7, Windows 8.x, Windows 10

The method for enabling Mock Locations differs for different Android devices. Generally, this is done under **Settings / Developer options, Allow mock locations**. Refer to the documentation for your device for specific instructions.

To use the GNSS Status utility with the R12 receiver:

1. Make sure the device you want to use has Bluetooth wireless technology turned on.
2. Make sure the receiver is turned on.
3. Depending on the device you want to connect the receiver to, do one of the following:
 - On a device powered by the Windows 7, 8.x, or 10 operating system, or Android versions 5.0 or later, use the GNSS Status utility to connect to the receiver.
 - a. Tap GNSS Status  to launch the GNSS Status utility. The device you are using searches for receivers within range.
 - b. If no receiver is connected, the utility shows **Location Services**. Select **Source** from the menu. From the **Position Source** dropdown, select **Bluetooth**. If you are using a Trimble TSC7 controller or T7 tablet or T10 tablet, you can also select **Internal Receiver** to use the device's internal GNSS receiver.
 - c. When the required receiver appears in the **Select Receiver** list, tap it, then tap **Select**.
 - On an iPhone or iPad, go to **Settings / Bluetooth**, and tap the R12 [ID] device you want to pair with.

To reconnect to a receiver at any time, make sure it is turned on, then:

- On a device powered by the Windows 7, 8.x, or 10 operating system, or Android versions 5.0 or later, use the GNSS Status utility to connect to the receiver:
 - a. Tap GNSS Status  to launch the GNSS Status utility.
 - b. Tap the R12 [ID] at the bottom of the screen to bring up the **Select Receiver** list. Tap the device [R12 ID] you want to reconnect to, then tap **Select**.
- On an iPhone or iPad, go to **Settings / Bluetooth**, and tap the R12 [ID] device you want to connect to.

For full instructions on using the GNSS Status utility, refer to the *Trimble GNSS Status Utility User Guide*.

Using Location Services

If no receiver is connected, the GNSS Status utility shows **Location Services** as the **Position Source**. Once a receiver is connected, it feeds GNSS positions to Location Services. All apps and web browsers that use Location Services have access to these GNSS positions

Logging data

Data logging involves the collection of GNSS measurement data over a period of time at a static point or points, and subsequent postprocessing of the information to accurately compute baseline information. Data logging using receivers requires access to suitable GNSS postprocessing software such as the Trimble Business Center software.

Postprocessed GNSS data is typically used for control network measurement applications and precise monitoring. GNSS measurement data is collected over a period of time at a static point or points and then postprocessed to accurately compute baseline information.

You can log data onto the R12 GNSS receiver itself, or onto a handheld device, smartphone, or tablet.

To log GNSS data using the R12 GNSS receiver:

- Connect the receiver to a Trimble handheld / controller using Bluetooth wireless technology. See [Configuring the receiver using Trimble software and Bluetooth wireless technology, page 47](#) for details on connecting the receiver. Use Trimble field software (for example, Trimble Access software, Trimble TerraFlex software) to log GNSS data from the receiver to the handheld / controller, or to a data card in the controller. For more information, refer to the user guide for your particular handheld /

controller, and the Trimble field software that you are using.

- Use the R12 GNSS receiver with the Trimble DL app on Android™ smartphones and tablets. The Trimble DL app is available to download from the Google Play store. Contact your local Trimble dealer for more information on the Trimble DL app for Android devices.
- To log received corrections onto the internal memory, connect to the Web Interface and go to **Data Logging / Summary / Configure** and select **Log Received Corrections**.

Logging data after a power loss

If power is unexpectedly lost while the receiver is logging data, the receiver tries to return to the state it was in immediately before the power loss. The receiver does not reset itself to default settings.

If the receiver was logging data when power was lost, it resumes logging data when power is restored.

Transferring files directly from the receiver

Data is stored in the internal flash memory. To transfer files between the receiver and an office computer, use one of the following methods.

- Lemo (Port 1) to traditional serial port and the Trimble Business Center.
- Lemo (Port 2) to USB PC connection (Trimble R12 GNSS receiver appears as a Trimble data external drive).
- Lemo (Port 2) to USB field data cable (transfer to USB flash memory stick and then plug flash memory stick into PC).
- Connect via Wi-Fi to the receiver's Web UI, then use the **Data Logging** menu to navigate to the receiver's file directory. Select the files to download to a directory on your PC, and the file format you want to download the data in (for example, RINEX).

Deleting files in the receiver

You can delete files stored in the receiver at any time. Do one of the following:

- Press  for 30 seconds after the receiver is turned on. (When you use this method, all data is deleted.)
- Use the web interface (**Data Logging** menu).

Default Settings

- [Default receiver settings](#)
- [Resetting the receiver to factory defaults](#)

All receiver settings are stored in application files. The default application file is stored permanently in the receiver, and contains the factory default settings for the receiver. Whenever the receiver is reset to its factory defaults, the current settings (stored in the current application file, `current.cfg`) are reset to the values in the default application file.

You cannot modify the default application file. However, if there is a power up application file (`Power_up.cfg`) in the receiver, the settings in this file can be applied immediately after the default application file, overriding the factory defaults.

Default receiver settings

These settings are defined in the default application file.

Function	Settings	Factory default
SVEnable	-	All SVs enabled
General Controls	Elevation mask	10°
	PDOP mask	25
	RTK positioning mode	Low Latency
	Motion	Kinematic
Serial Port 1	Baud rate	38,400
	Format	8-None-1
	Flow control	None
Serial Port 2	USB	

Function	Settings	Factory default
Input Setup	Station	Any
NMEA/ASCII (all supported messages)		All ports Off
Streamed Output		All types Off Offset=00
RT27/RT17/Binary		All ports Off
Reference Position	Latitude	0°
	Longitude	0°
	Altitude	0.00 m HAE
Antenna	Type	Trimble R12 GNSS receiver, Internal
	Height (true vertical)	0.00 m
	Group	All
	Measurement method	Antenna Phase Center

Resetting the receiver to factory defaults

To reset the receiver to its factory defaults, press and hold down the receiver's Power button for 15 seconds.

- The Radio, Wi-Fi, and Satellite LEDs turn off after 2 seconds.
- The battery LED remains on.
- After 15 seconds, the Satellite LED comes on to indicate that it is time to release the Power button.
- Upon restart, the Wi-Fi will also turn on in Access Point mode.

Base Station Operation

- [Base station operation guidelines](#)
- [Common ways to set up a base station](#)
- [Outputting corrections using a TDL450/HPB450 radio-modem](#)

Base station operation guidelines

This topic introduces the concept of base station operation, provides information to help you identify good setup locations, describes best practices for setting up the equipment, and outlines the precautions that you need to take to protect the equipment.

Real-Time Kinematic (RTK) operation provides centimeter-level precision by eliminating errors that are present in the GNSS system. For all RTK operations, you require both a rover receiver and a source of corrections from a base station or network of base stations.

A base station consists of a receiver that is placed at a known (and fixed) position. The receiver tracks the same satellites that are being tracked by the rover receiver, at the same time that the rover is tracking them. Errors in the GNSS system are monitored at the fixed (and known) base station, and a series of position corrections are computed. The messages are sent through a radio link to the rover receiver, where they are used to correct the real time positions of the rover.

Base station components

The base station has the following components:

- GNSS receiver
- GNSS antenna
- Height extension pole with measurement level
- Base station radio and antenna
- Power source

GNSS receiver and GNSS antenna

The base station GNSS receiver can be one of following types:

- An integrated receiver that incorporates a GNSS receiver, GNSS antenna, power source, and radio into a single compact unit. An integrated GNSS antenna can be rapidly set up on a tripod or fixed height tripod, or anywhere that is convenient on the jobsite.
- A modular receiver that incorporates a GNSS receiver and separate GNSS antenna. The GNSS antenna (and, optionally, the base station radio antenna) is separate from the receiver. Because the GNSS antenna is separate, you can use the following optimized components:
 - a geodetic antenna with large ground plane, to eliminate multipath (the major source of GNSS errors) at the base station
 - a high-gain or directional radio antenna, to increase broadcast range and to provide maximum coverage

You can place a modular receiver in an easily accessible and secure location, safe from theft and the weather, while the antennas are placed high on a tower or building, clear of obstructions and able to deliver maximum performance.

You can use either type of receiver in a permanent, semi-permanent, or daily quick setup configuration. If semi-permanent or permanent operation is required, however, the modular receiver delivers significant advantages.

Base station setup guidelines

For good performance, observe the following base station setup guidelines:

- Place the GNSS receiver in a location on the jobsite where equal range in all directions provides full coverage of the site. This is more important on larger jobsites, where the broadcast range of the base station radio may limit the operations of the system.
- Place the GNSS antenna in a location that has a clear line of sight to the sky in all directions. Do not place the antenna near vertical obstructions such as buildings, deep cuttings, site vehicles, towers, or tree canopy.
- Place the GNSS and radio antennas as high as practical. This minimizes multipath from the surrounding area, and enables the radio to broadcast to the maximum distance.

***NOTE** – The GNSS antenna must have a clear line of sight to the sky at all times during operation.*

- Choose the most appropriate radio antenna for the size and footprint of the site. The higher the gain on the antenna, the longer the range. If there is more focus on the transmission signal, there is a reduced coverage area. A 5 db gain antenna provides a

mix of good range and reasonable directional coverage.

***NOTE** – A 5 db gain antenna with remote mount and cable is available as an accessory for the internal radio (P/N 89856-00-6x).*

- Make sure that the GNSS receiver does not lose power. To operate continuously for more than a few hours without loss of power at the base station, provide external power. Sources of external power include:

- AC power
- 12 V vehicle battery
- Trimble custom external battery pack (P/N 32364-10)
- Generator power
- Solar panel

When you use an external power supply, the integrated battery provides a backup power supply, enabling you to maintain continuous operation through a mains power failure.

- Do not locate a GNSS receiver, GNSS antenna, or radio antenna within 400 meters (about 1,300 feet) of:

- a powerful radar, television, or cellular communications tower
- another transmitter

Cell phone towers can interfere with the base station radio broadcast and can stop corrections from reaching the rover receiver. High-power signals from a nearby radio or radar transmitter can overwhelm the receiver circuits. This does not harm the receiver, but can prevent the receiver electronics from functioning correctly.

Low-power transmitters, such as those in cell phones and two-way radios, do not interfere with receiver operations

- Do not set up the base station directly beneath or close to overhead power lines or electrical generation facilities. The electromagnetic fields associated with these utilities can interfere with GNSS receiver operation. Other sources of electromagnetic interference include:

- Gasoline engines (spark plugs)
- Televisions and computer monitors
- Alternators and generators
- Electric motors
- Equipment with DC-to-AC converters

- Fluorescent lights
- Switching power supplies
- Place the GNSS receivers in a protected and secure location. If the base station is in the center of a jobsite where heavy machinery is operating, place flags around the base station to warn operators of its existence.
- If you place the receiver in a lock box on the jobsite to protect the receiver from theft or from the weather, shield the lock box from direct sunlight and provide ventilation for the receiver through an inlet and extractor fan. A receiver that has a broadcast radio generates significant heat. Do not allow the temperature in the box to exceed 50 °C (122 °F).

If working in a cold climate, you may need to provide heat to the receiver. Do not operate the receiver below –40 °C (–40 °F)

- Trimble recommends that, wherever possible, you keep GNSS receiver equipment dry. The receivers are designed to withstand wet weather, but keeping them dry prolongs their life and reduces the effects of corrosion on ports and connectors. If the equipment gets wet, use a clean dry cloth to dry the equipment and then leave the equipment open to the air to dry. Do not lock wet equipment in a transport case for prolonged periods. Avoid exposing the receiver to corrosive liquids and salt water wherever possible.
- Trimble recommends that you install lightning protection equipment at permanent base station locations. Equipment should include a gas capsule lightning protector in the GNSS and radio antenna feed line and appropriate safety grounding. A static dissipater near the antennas can reduce the likelihood of a direct lightning strike. Also protect any communications and power lines at building entry points. For more information, contact your local Trimble dealer, or go to the Huber and Suhner website (www.hubersuhnerinc.com).
- Trimble recommends that you use surge protection equipment on all permanently installed equipment.

Common ways to set up a base station

Trimble recommends that you use a tripod and tribrach setup or a fixed height tripod. The fixed height tripod is quicker and easier to set up over a control point.

Take great care to ensure that the GNSS antenna is set up accurately over the control point, and that the GNSS antenna height is measured accurately, in the right way (vertical or slope height) to the right location on the antenna (base of antenna or to a specified location on the antenna) or height extension pole with height measurement lever (P/N 89846-00) or Base Station Kit (P/N 89861-00). When you start the rover receiver, it is

important to check in, at one or more known locations, to check for possible position or height errors. Checking in at a known location is good practice and can avoid costly errors caused by a bad setup.

Tripod and tribrach setup

In the tripod setup, the tripod is located over the control point, and the tribrach, tribrach adaptor, and height extension pole with measurement lever is mounted on the tripod and centered over the point.

1. Mount the quick release adapter onto the height extension pole with measurement lever.
2. Screw the height extension pole with measurement lever into the tribrach. Attach the GNSS receiver to the quick release adapter.
3. Level and plumb the GNSS receiver over the control point.
4. Measure the height of the base station GNSS antenna by measuring the slant height from the control point to the measurement lever. Select the “Lever of R10 extension” as the measurement method when starting the base station. Trimble Access calculates the height to the Antenna Phase Center (APC) automatically.
5. If required, connect the GNSS receiver to an external 12 V power supply. Use the external battery cable set (P/N 89864-00) or the Trimble custom 6 Ah power pack (P/N 32364-10).



Receiver tripod and tribrach setup with an internal 450 MHz Tx radio (Measuring Slant Height)

Fixed height tripod setup

A fixed height tripod (P/N 28959-00) setup is similar to a tripod setup, but is simplified by the central leg of the tripod, which is placed directly on the control point. If the central leg is

leveled accurately, the fixed height tripod is quick and easy to set up, and provides an accurate way to measure the true antenna height.

1. Screw the quick release adapter onto the tripod head or extension pole used to increase the height of the receiver above the tripod head.
2. Attach the GNSS receiver to the quick release adapter.
3. Plumb and level the tripod over the control point.
4. Determine the height of the base station GNSS antenna by adding the fixed height of the tripod from the control point to the tripod head to the height of any extension pole used to increase the height of the receiver. Select the “Bottom of Quick Release” as the measurement method when starting the base station. Trimble Access calculates the height to the Antenna Phase Center (APC) automatically.
5. If required, connect the GNSS receiver to an external 12 V power supply. Use the crocodile clip cable or the Trimble custom power pack.



- ❶ Base extension with height measurement lever
- ❷ Standard 20 cm extension pole

Receiver with an internal 450 MHz Transmit radio on a fixed height tripod

NOTE – *Measuring to the measurement lever is not required when using a fixed height tripod. If the base station extension with measurement lever is used with a fixed height tripod, the height of the extension pole (0.15m (0.49ft)) should be added to the height of the fixed height tripod and the measurement method “bottom of quick release” used.*

Using a remote radio antenna with the receiver

A remote radio antenna can be used with the Trimble R12 GNSS receiver's internal 450 MHz radio. The remote antenna allows the use of a high gain antenna (country dependent) and the ability to increase the height of the radio antenna for a larger coverage area. The remote antenna cable and mount, along with the high gain antenna, is available as an accessory for the receiver (P/N 89856-00-6x, radio frequency dependent).

Typically, the tripod and fixed height tripod methods do not give significant height clearance above the ground, and can reduce the range of operation caused by radio limitations.



Connecting remote radio antenna cable to the receiver



Receiver with a remote radio antenna

Using an external radio with the receiver

An external radio can be used with the Trimble R12 GNSS receiver. Using a high powered UHF radio will increase the radio coverage area. The external radio data cable is connected to Port 1 (Serial) on the receiver.

Outputting corrections using a TDL450/HPB450 radio-modem

The TDL450/HPB450 radio comes with a 5-pin Lemo to 7-pin Lemo connector with a power connection lead (P/N 66656-00):

1. Connect the 7-pin Lemo connector to the serial port (Port 1) on the receiver.
2. Connect the 5-pin Lemo connector to the TDL450/HPB450 radio.
3. Connect the DC power lead to an external power source.
4. Turn on the TDL450/HPB450 radio.

To configure the system, do one of the following:

- Use the Trimble Access software to connect to the receiver. Set up the base station with the external radio. The Trimble Access software will locate the TDL450/HPB450 radio and then allow you to set the radio channel.
- Use the web interface to configure the settings. Select **I/O Configuration / Port Configuration**. Select the **Serial 1 / Lemo** option and select corrections to be sent on the Lemo port at those baud rate settings (the TDL450/HPB450 serial interface is shipped with the default rates 38400 8/N/1).

Configuration software accompanies the TDL450/HPB450 radio if you need to change the serial connection baud rate.

Rover Setup and Operation

- [Rover operation guidelines](#)
- [Connecting the receiver to external devices](#)
- [Integrated cellular modem](#)
- [SurePoint \(advanced sensors\)](#)

Rover operation guidelines

Real-Time Kinematic (RTK) operation provides centimeter-level precision by eliminating errors that are present in the GNSS system. For all RTK operations, you require both a rover receiver and a source of corrections from a base station or network of base stations.

This topic introduces the concept of rover operation, provides information to help you identify good setup locations, describes best practices for setting up the equipment, and outlines the precautions that you need to take to protect the equipment.

The second part of the RTK GNSS system is the rover receiver. The rover receiver is moved between the points that require measurement or stakeout. The rover receiver is connected to a base station or to a source of RTK corrections such as a VRS™ system or the Trimble CenterPoint RTX correction service. The connection is provided by:

- an integrated radio
- an integrated cellular modem
- an integrated Wi-Fi module
- a cellular modem in the controller
- an integrated GNSS antenna (L-Band)

In most rover applications, the receiver operates entirely from its own integrated battery unit. However, you can use an external power supply if one is provided. The internal battery then acts as an uninterruptible power supply, covering any external power failures.

For good rover operation, observe the following setup guidelines:

- Place the GNSS antenna in a location that has a clear line of sight to the sky in all directions. Do not place the antenna near vertical obstructions such as buildings, deep cuttings, site vehicles, towers, or tree canopy. GNSS rovers and the base station receive the same satellite signals from the same satellites. The system needs five common satellites to provide RTK positioning.

 **WARNING** – The GNSS receiver and its cabling should be installed in accordance with all national and local electrical codes, regulations, and practices. The receiver and cabling should be installed where they will not become energized as a result of falling nearby power lines, nor be mounted where they are subjected to over-voltage transients, particularly lightning. Such installations require additional protective means that are detailed in national and local electrical codes.

 **WARNING** – Take care not to touch overhead power lines with the Trimble R12 GNSS receiver or the range pole when moving the equipment into position. Touching overhead power lines may cause electrocution, leading to serious injury.

- GNSS satellites are constantly moving. Because you cannot measure at a specific location now does not mean that you will not be able to measure there later, when satellite coverage at the location improves. Use GNSS planning software to identify the daily best and worst satellite coverage times for your location and then choose measurement times that coincide with optimal GNSS performance. This is especially important when operating in the worst GNSS locations. You can use Trimble GNSS Planning Online at www.gnssplanning.com.

- To get a fixed position solution with centimeter precision, initialize the RTK rover receiver. For initialization to take place, the receiver must track at least five satellites that the base station is also tracking. In a dual-satellite constellation operation, for example, GPS and GLONASS, the receiver must track at least six satellites.
- To continue to survey at centimeter precisions, the rover must continuously track at least four satellites that the base station is also tracking. The radio link between the base and rover receivers must also be maintained.
- Loss of the satellite signals will result in a loss of centimeter position precision.
- If the radio link or cellular signal is lost, xFill takes over, which allows for centimeter precisions.

⚠ CAUTION – The Trimble R12 GNSS receiver is not suited to on-vehicle operation where it will be subject to heavy vibration, that is, operation in rough ungraded terrain. Use in these conditions can damage the receiver.



Connecting the receiver to external devices

You can connect the receiver to the following devices:

- a Trimble controller running Trimble Access software
- Android devices running supported apps
- iOS devices running supported apps
- an external radio-modem

Connecting to a Trimble controller running Trimble Access software

You can operate a Trimble R12 GNSS receiver with the latest generation of Trimble controllers, for example, a TSC7 or the Trimble T10 tablet. Typically, the receiver and the controller operate from their own individual power sources. The receiver and controller can communicate through Bluetooth wireless technology and can be connected without a

cable. However, if a cable is required, the following table lists the cables available for the receiver.

To connect a Trimble R12 GNSS receiver to a...	Use cable P/N...	Use cable connector...	and connect the cable to the...
computer serial port	89853-00 or 59044	7-pin serial Lemo DB-9	Receiver Computer
computer USB port	89852-00 or 80751	7-pin USB Lemo USB	Receiver Computer
TSC7 or Trimble T10 or T7 tablet	89851-00 or 59046	DB-9 Serial Lemo	TSC Receiver
USB flash memory stick	89850-00 or 80799	7-pin USB Lemo USB flash drive	Receiver Flash drive
TDL450	66656-00	7-pin serial Lemo 5-pin Lemo	Receiver TDL450

Internal radio-modems

The most common data link for Real-Time Kinematic (RTK) operation is a radio. The receiver is available with the following internal radios:

- 410 MHz – 470 MHz (Transmit/Receive)

External radio-modems

If the receiver does not have an internal transmit radio, or you want to connect to a higher powered external transmit radio or cellular modem, use the Lemo serial port.

The Trimble R12 GNSS receiver supports the following Trimble base radios:

- Trimble TDL450
- Legacy radios such as the Trimble PDL450 radio, Trimble HPB450 radio-modem, and TRIMMARK™ 3 radio

The receiver also supports third-party transparent radios and third-party cellular modems.

To use an external radio with the receiver, you need an external power source for the radio. To configure the radio modem separately, use the external radio's configuration program, or the display and keypad.

Integrated cellular modem

Instead of the internal radio, you can use the integrated cellular modem as your data communications link. This will allow you to connect to VRS networks in your area. See your local Trimble representative for more information on VRS networks.

Using the integrated cellular modem requires a SIM card from your local cellular service provider. The SIM card is inserted into the SIM card slot in the battery compartment of the receiver. For more information about setting up your SIM card and cellular service in the receiver, please see your local Trimble representative.

For more information on using a cellular modem as a data link, refer to the *Trimble Access Help portal*.

SurePoint (advanced sensors)

The receiver comes with the SurePoint™ technology, which allows the use of full tilt compensation and an eBubble (electronic bubble). SurePoint's full tilt compensation allows the collection of points even when the receiver is tilted up to 15 degrees off plumb. When the terrain or obstacles around the point do not allow full plumbing of the receiver, the integrated tilt sensor will compensate for the tilt of the range pole. The point is collected using a point type of *compensated point* to initiate the tilt compensation. The eBubble is displayed within the Trimble Access software. The eBubble is displayed in a separate window for use during any aspect of your survey. To use the full tilt compensation and the eBubble correctly, the TSC7 controller or T10 tablet must be aligned correctly in relationship to the receiver. When the receiver is placed on a range pole, the controller or tablet must be placed on the right or left side of the receiver with the screen of the controller or tablet in the same axis as the receiver front panel.

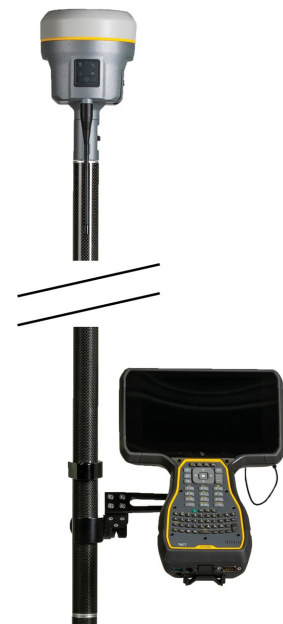

Calibrating the integrated tilt sensor and magnetometer

It is very important to ensure the integrated tilt sensor is correctly calibrated in the same way that mechanical bubbles are calibrated on your range poles and tribrachs. When calibrating the integrated tilt sensor you must use a range pole with bipod or a tripod with

tribrach that have been well calibrated. The quality of the integrated tilt sensor calibration is directly related to the quality of the mechanic bubble and its calibration.

The integrated tilt sensor calibration is performed within the Trimble Access software. To calibrate the integrated tilt sensor, place the receiver on a stable range pole or tripod with tribrach. Level the receiver using the mechanical bubble on the range pole or tribrach. Turn on the receiver and TSC7 controller or T10 tablet. Run Trimble Access, then:

1. In the General Survey menu, select **Instrument**, then **eBubble options**.

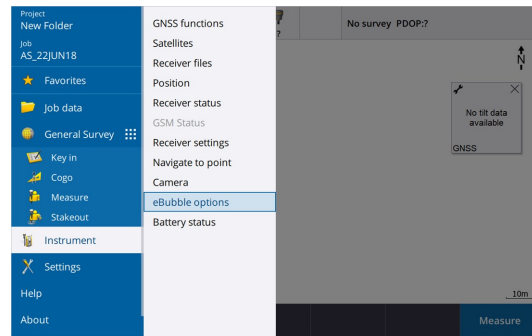

2. The **eBubble options** screen appears.

You are now ready to perform the calibration.

Tap **Calib**.

***NOTE** – An electronic bubble is displayed to indicate if you are holding the instrument level.*

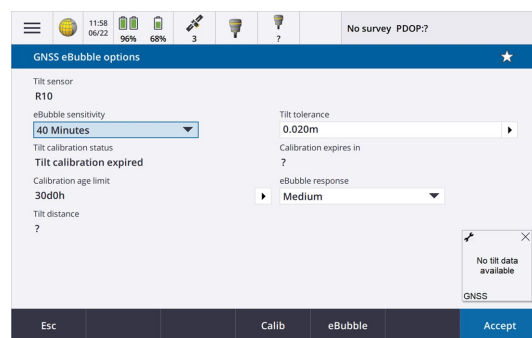

3. The **Sensor calibration** screen appears.

First the tilt calibration is performed.

Tap the **Calibrate** button next to the **Tilt calibration status** field.

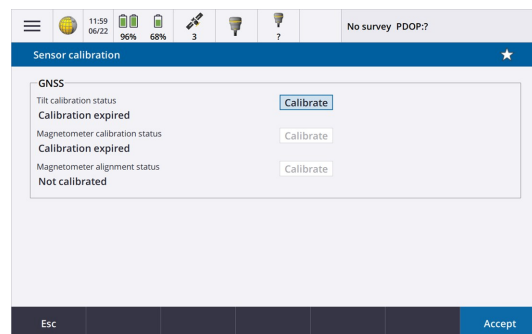

4. A message asks you to confirm that the instrument is level and braced against any movement.

Tap **Start**.

5. A progress bar indicates that calibration is in progress.

6. Once calibration is complete, the **Sensor calibration** screen reappears. Next you will perform the magnetometer calibration. Tap the **Calibrate** button next to the **Magnetometer calibration status** field.

7. A message and graphic is displayed describing the magnetometer calibration procedure. Observe the visual graphic of the receiver, and then perform the calibration as shown. Tap **Start**.

8. As you rotate the receiver through the 12 orientations, the progress bar will progress. If the bar is not progressing or progressing slowly, you may not be rotating the receiver correctly. Rotate the receiver in the vertical one complete rotation, then rotate the receiver in the horizontal a few degrees. Repeat.

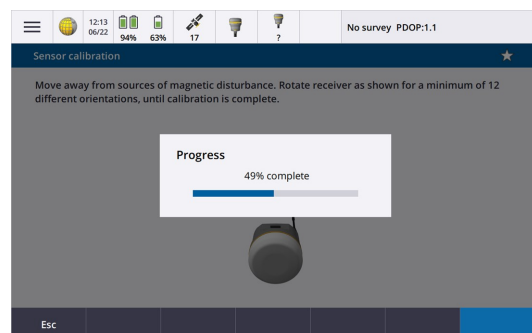
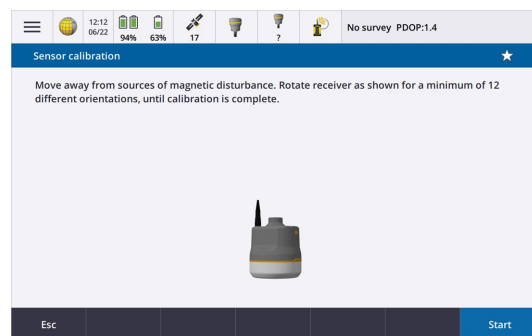
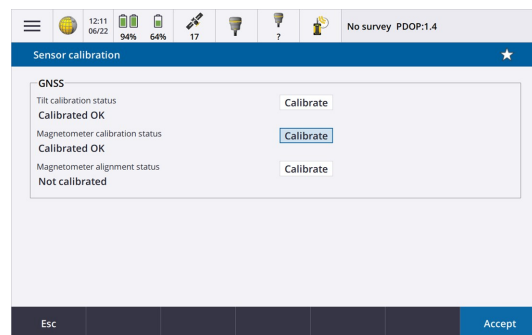
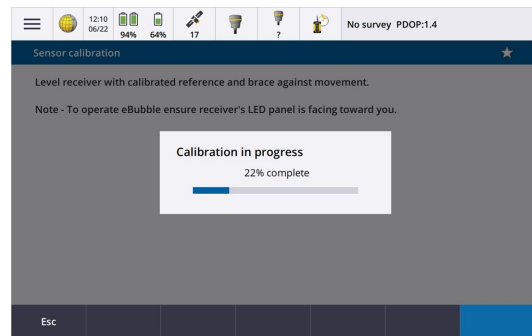

9. Once calibration is complete, the **Sensor calibration** screen reappears. Next you will perform the magnetometer alignment.
- Tap the **Calibrate** button next to the **Magnetometer alignment** status field.

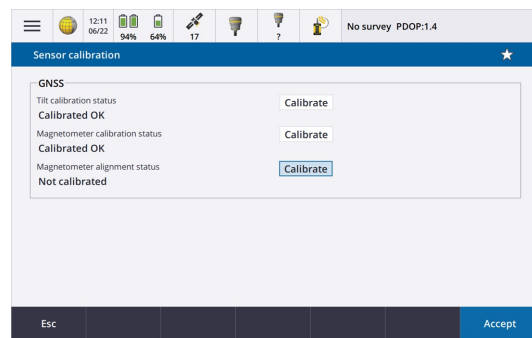

10. A message and graphic is displayed describing the magnetometer alignment procedure. Observe the visual graphic of the receiver, and then perform the alignment as shown. Tap **Start**.

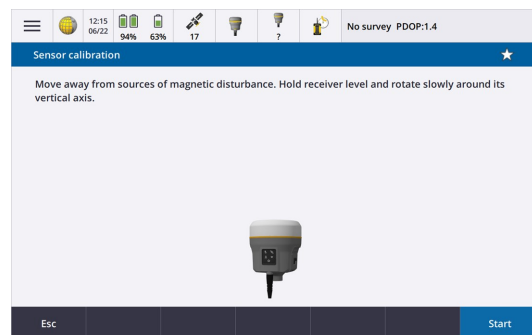

11. As you rotate the receiver 360 degrees in the horizontal, the progress bar will progress. If the bar is not progressing or progressing slowly, you may be rotating the receiver too quickly. Rotate the receiver at the same speed as the graphic shows.

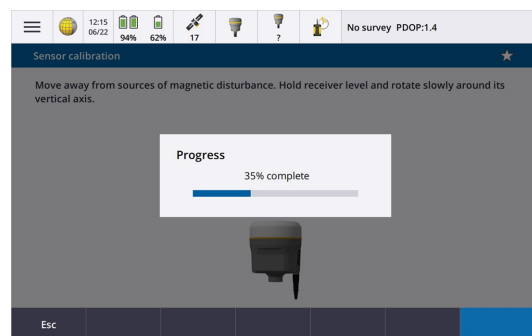

12. Once calibration is complete, the **Sensor calibration** screen reappears. The full tilt calibration is complete. Tap **Accept** to return to the **eBubble options** screen.

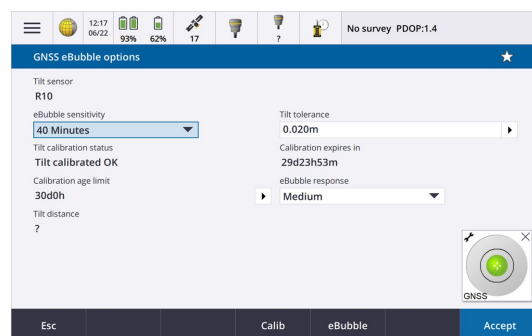
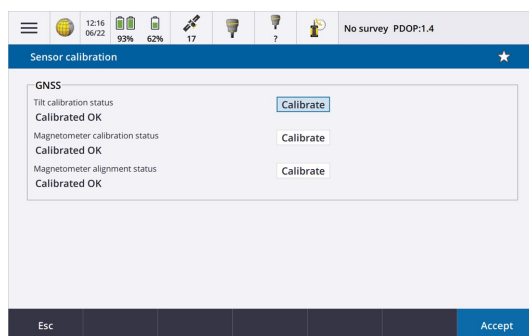

Trimble Installation Manager

- [Trimble Installation Manager functions and features](#)
- [Installing Trimble Installation Manager](#)
- [Upgrading the receiver firmware](#)
- [Updating the radio frequency list](#)

Trimble Installation Manager functions and features

Use Trimble Installation Manager to:

- Update supported Trimble GNSS receivers
- Update supported Trimble instrument firmware
- Install and update supported Trimble software on Trimble field controllers and office computers

The primary Trimble Installation Manager features for GNSS receivers are:

- Warranty Activation
- Option Loading
- Radio Configuration
- Firmware Installation

The following Trimble GNSS receivers are currently supported:

	R12	R10-2	R10-1	R9s	R8s	R2
Warranty Activation	•	•		•	•	•
Option Loading	•	•		•	•	•
Radio Configuration	•	•		•	•	•
Firmware Installation	•	•	•	•	•	•

Installing Trimble Installation Manager

Trimble Installation Manager is a free download and can be found at:

<http://www.trimble.com/installationmanager>

Upgrading the receiver firmware

To upgrade the firmware on your receiver:

1. Launch Trimble Installation Manager.
2. Connect the receiver with the appropriate data cable to your computer, and click **Connect**.

***NOTE** – If your computer only has USB ports, then you must set up a virtual serial port. See [Configuring a PC USB port as a virtual serial port](#), page 37.*

3. Trimble Installation Manager will display receiver-specific information. From the menu in the top right corner, select the firmware version you want to install, then click **Install**.

Download Trimble Survey GNSS Firmware to a local machine using Trimble Installation Manager

Trimble GNSS firmware for supported receivers can also be downloaded and saved to your local machine via Trimble Installation manager.

1. Launch Trimble Installation Manager. You do not need to have a receiver connected to your computer.
2. Click the **Receiver** tab.
3. Click the **Download** button  (top right corner).
4. Select the appropriate receiver model on the left.
5. Select the required firmware version from the dropdown menu in the upper right. The latest release is selected by default.
6. Click **Download**.
7. Browse to the location where you would like to save the file and click **OK**. The firmware file is saved to a folder labeled with the receiver model and firmware version.

Updating the radio frequency list

You can program the internal transceiver modem with a list of up to 20 frequencies, which are stored in non-volatile memory. This list is pre-configured based on the frequencies that you requested when you ordered the unit.

Government regulations stipulate that only manufacturers or authorized dealers can create this frequency list and that all frequencies programmed into a unit must comply with the host country regulations.

If you need to add, delete, or replace frequencies, contact your Trimble dealer, and provide the receiver serial number and an updated list of the frequencies you require. Once your dealer has assigned frequencies to your receiver, you can update the radio by connecting your receiver to your computer and running Trimble Installation Manager.

***NOTE** – Receive-only radio frequencies can be added through the receiver web user interface. See [Adding and removing receive-only frequencies for the 450 MHz internal radio using the web interface, page 46](#).*

Troubleshooting

- [Troubleshooting receiver issues](#)
- [Troubleshooting LED conditions](#)
- [Troubleshooting base station setup and static measurement problems](#)

Troubleshooting receiver issues

This section describes some possible receiver issues, possible causes, and how to solve them. Please read this section before you contact Technical Support.

The receiver does not turn on

Possible cause	Solution
External power is too low.	Check the charge on the external power supply, and check the fuse if applicable. If required, replace the battery.
Internal power is too low.	Do the following: <ul style="list-style-type: none"> • Check the charge on the internal batteries and replace if required • Ensure battery contacts are clean.
External power is not properly connected.	Do the following: <ul style="list-style-type: none"> • Check that the Lemo connection is seated properly. • Check for broken or bent pins in the connector.
Faulty external power cable.	Do the following: <ul style="list-style-type: none"> • Try a different cable. • Check pinouts with multimeter to ensure internal wiring is intact.

The receiver is not tracking any satellites

Possible cause	Solution
The GNSS antenna does not have clear line of sight to the sky.	Ensure that the antenna has a clear line of sight.

The receiver does not log data

Possible cause	Solution
Insufficient memory in the internal memory.	Delete old files. Press the Power button for 30 seconds.

The receiver is not responding

Possible cause	Solution
The receiver needs a soft reset.	Turn off the receiver and then turn it back on again. For more information, see Button and LED operations, page 32
The receiver needs a full reset.	Press the Power button for 30 seconds. For more information, see Button and LED operations, page 32 .

Troubleshooting LED conditions

The receiver has a simple display panel with LEDs to indicate the current status of the receiver. If you need more detailed information about what the receiver is doing, use a Trimble controller or access all configuration settings by connecting the receiver to your smart phone or laptop computer via [Configuring the receiver using Wi-Fi and the Web Interface, page 39](#).

This section describes how the LED lights are used on the receiver to indicate current status. An LED that is flashing quickly indicates a condition that may require attention, and an unlit LED indicates that no operation is occurring. This section describes some LED conditions, possible causes, and how to solve them.

The SV Tracking LED is lit solidly and the Logging/Memory LED is flashing slowly

Possible cause	Solution
The receiver is in Monitor mode, ready	Turn on or turn off the receiver. If that does not fix the problem, load the latest version of the firmware using Trimble Installation

Possible cause	Solution
for new firmware to be loaded or new options to be added.	Manager. See Upgrading the receiver firmware, page 71 .

The SV Tracking LED is not flashing

Possible cause	Solution
The receiver is tracking fewer than four satellites.	Wait until the SV Tracking LED is flashing slowly.

Troubleshooting base station setup and static measurement problems

This section describes some possible station setup and static measurement issues, possible causes, and how to solve them.

Trimble recommends that you use the Trimble Access software to restart or configure base and rover receivers. The Trimble Access software sets up all radio and receiver operating parameters, and is the most likely route to a successful problem resolution once you have checked all connections, cables, and batteries.

The roving receiver is not receiving radio from the base station

Possible cause	Solution
The base station is not broadcasting.	See "Base station is not broadcasting" below.
Incorrect over-the-air baud rates between base station and rover.	Connect to the roving receiver's radio and make sure that it has the same setting as the base station receiver.
Mismatched channel or network number selection.	Match the base station and rover radio channels/network number and try again.
Incorrect port settings between the rover external radio and receiver.	If the radio is receiving data (the Radio LED is flashing) and the receiver is not receiving data, check the port settings of the receiver and radio using the Trimble Access software; match the settings and try again.

The base station is not broadcasting

Possible cause	Solution
<p>Port settings between base receiver and external radio are incorrect.</p> <p>NOTE – The receiver has the option for an integrated Tx radio that allows it to be used without an external radio at the base and rover location. The receiver can also be connected to an external high power radio in certain countries.</p>	<p>Use Trimble Access software to connect to the radio through the receiver. If no connection is made, connect directly to the radio and change the port settings. Try to connect through the receiver again to ensure that they are communicating.</p> <p>NOTE – Trimble Access software does not support direct connection to the external radio; it only allows configuration through the receiver.</p>
<p>Faulty cable between receiver and external radio.</p>	<p>Do one of the following:</p> <ul style="list-style-type: none"> • Try a different cable • Examine the ports for missing pins • Use a multimeter to check the pins

Output Messages

- [NMEA-0183 messages: Overview](#)
- [NMEA-0183 messages: Common message elements](#)
- [RTCM Output: Generated messages](#)
- [GSOF Messages: Overview](#)
- [GSOF messages: General Serial Output Format](#)
- [GSOF messages: Reading binary values \(Motorola format\)](#)

This section provides information about two types of messages: General Serial Output Format (GSOF) messages and National Marine Electronics Association (NMEA) messages.

NMEA-0183 messages: Overview

When NMEA-0183 output is enabled, a subset of NMEA-0183 messages can be output to external instruments and equipment connected to the receiver serial ports. These NMEA-0183 messages let external devices use selected data collected or computed by the GNSS receiver.

All messages conform to the NMEA-0183 version 3.01 format. All begin with \$ and end with a carriage return and a line feed. Data fields follow comma (,) delimiters and are variable in length. Null fields still follow comma (,) delimiters, but contain no information.

An asterisk (*) delimiter and checksum value follow the last field of data contained in an NMEA-0183 message. The checksum is the 8-bit exclusive of all characters in the message, including the commas between fields, but not including the \$ and asterisk delimiters. The hexadecimal result is converted to two ASCII characters (0–9, A–F). The most significant character appears first.

The following table summarizes the set of NMEA messages supported by the receiver.

Message	Function
DTM	Datum reference information
GBS	GNSS satellite fault detection (RAIM support)
GLL	Position data: position fix, time of position fix, and status
GNS	GNS Fix data
GRS	GRS range residuals
GSA	GPS DOP and active satellites
GST	Position error statistics
GSV	Number of SVs in view, PRN, elevation, azimuth, and SNR
HDT	Heading from True North
LLQ	Leica local position and quality
PFUGDP	A proprietary message containing information about the type of positioning system, position, number of satellites and position statistics
PTNL,AVR	Time, yaw, tilt, range, mode, PDOP, and number of SVs for Moving Baseline RTK
PTNL,BPQ	Base station position and position quality indicator

Message	Function
PTNL,DG	L-band corrections and beacon signal strength and related information
PTNL,GGK	Time, position, position type, and DOP values
PTNL,PJK	Time, position, position type, and DOP values
PTNL,PJT	Projection type
PTNL,VGK	Time, locator vector, type, and DOP values
PTNL,VHD	Heading Information
RMC	Position, Velocity, and Time
ROT	Rate of turn
VTG	Actual track made good and speed over ground
ZDA	UTC day, month, and year, and local time zone offset

To enable or disable the output of individual NMEA messages:

1. In the receiver WebUI, select **I/O Configuration** and choose the desired port to output NMEA messages.
2. Select **NMEA** as the output message type and then enable or disable individual NMEA messages as required.

For a copy of the NMEA-0183 Standard, go to the National Marine Electronics Association website at www.nmea.org.

NMEA-0183 messages: Common message elements

Each message contains:

- a message ID consisting of \$GP followed by the message type. For example, the message ID of the GGA message is \$GPGGA.
- a comma.
- a number of fields, depending on the message type, separated by commas.
- an asterisk.
- a checksum value.

The following example shows a simple message with a message ID (\$GPGGA), followed by 13 fields and a checksum value:

```
$GPGGA,172814.0,3723.46587704,N,12202.26957864,W,2,6,1.2,18.893,M,-
25.669,M,2.0,0031*4F
```

NMEA Message values

NMEA messages that the receiver generates contains the following values:

Value	Description
Latitude and Longitude	Latitude is represented as ddmm.mmmm and longitude is represented as dddmm.mmmm, where: <ul style="list-style-type: none"> • dd or ddd is degrees • mm.mmmm is minutes and decimal fractions of minutes
Direction	Direction (north, south, east, or west) is represented by a single character: N , S , E , or W.
Time	Time values are presented in Universal Time Coordinated (UTC) and are represented as hhmmss.ss, where: <ul style="list-style-type: none"> • hh is hours, from 00 through 23 • mm is minutes • ss.ss is seconds with variable length decimal-fraction of seconds

RTCM Output: Generated messages

Messages that are generated when you select a specific RTCM version are shown in the following table. For details of the individual messages, refer to the RTCM documentation at www.rtcmm.org.

Selection	Message						
Version 2	1	3			22		59
USCG, 9-3		3	9-3				
RTCM/RTK, 2.2+2.3	1	3	18	19	22	23	24 59
RTK Only, 2.2+2.3		3	18	19	22	23	24 59
RTCM/RTK, 2.3			18	19		23	24
RTK Only, 2.3			18	19	22		
RTCM/RTK, 2.2	1	3	18	19	22		59
RTK Only, 2.2		3	18	19	22		59
RTCM/RTK, 2.1	1	3	18	19	22		59
RTK Only, 2.1		3	18	19	22		59
RTCM/RTK, 3.x			1004	1006	1008	1012	1013 1033

GSOF Messages: Overview

These topics provide information on the General Serial Output Format (GSOF) messages. GSOF messages are a Trimble proprietary format and can be used to send information such as position and status to a third-party device.

This table summarizes the GSOF messages that the receiver supports. When GSOF output is enabled, the following messages can be generated:

Message	Function
Lat, Long, Ht	Latitude, longitude, height
Local ENU	Local zone north, east, and height - projection/calibration based

For information on how to output GSOF messages, see [Configuring and using the receiver](#), page 31.

GSOF messages: General Serial Output Format

Report packet 40h structure (GENOUT)

Byte	Item	Type	Value	Meaning
0	STX	Char	02h	Start transmission
1	STATUS	Char	See Receiver status code	Receiver status code
2	PACKET TYPE	Char	40h	Report Packet 40h (GENOUT)
3	LENGTH	Char	00h–FAh	Data byte count
4	TRANSMISSION NUMBER	Char		Unique number assigned to a group of record packet pages. Prevents page mismatches when multiple sets of record packets exist in output stream.
5	PAGE INDEX	Char	00h–FFh	Index of current packet page.
6	MAX PAGE INDEX	Char	00h–FFh	Maximum index of last packet in one group of records.
One or more GSOF messages				
	Output record type	Char	01h	For example, Time (Type 1 Record)
	Record length	Char	0Ah	Bytes in record
Various fields depending on Output record type.				
There can be various records in one GENOUT packet. There could be multiple GENOUT packets per epoch. Records may be split over two consecutive packets.				
Length + 4	CHECKSUM	–	–	(Status + type + length + data bytes) modulo 256
Length + 5	ETX		03h	End transmission

Each message begins with a 4-byte header, followed by the bytes of data in each packet. The packet ends with a 2-byte trailer. Byte 3 is set to 0 (00h) when the packet contains no data. Most data is transmitted between the receiver and remote device in binary format.

Receiver Status code

Byte number	Description
Bit 0	Reserved
Bit 1	If set, low battery at the base station
Bit 2	Reserved
Bit 3	If set, receiver's kinematic state is currently set to 'Roving', otherwise 'static'
Bit 4–7	Reserved

GSOF messages: Reading binary values (Motorola format)

The receivers store numbers in Motorola format. The byte order of these numbers is the opposite of what personal computers (Intel format) expect. To supply or interpret binary numbers (8-byte DOUBLES, 4-byte LONGS, and 2-byte INTEGERS), the byte order of these values must be reversed. This section contains a detailed description of the Motorola format.

INTEGER data types

The INTEGER data types (CHAR, SHORT, and LONG) can be signed or unsigned. By default, they are unsigned. All integer data types use two's complement representation. The following table lists the integer data types:

Type	# of bits	Range of values (Signed)	Unsigned
Char	8	-128 to 127	0 to 255
Short	16	-32768 to 32767	0 to 65535
Long	32	-2147483648 to 2147483647	0 to 4294967295

FLOATING-POINT data types

Floating-point data types are stored in the IEEE SINGLE and DOUBLE precision formats. Both formats have a sign bit field, an exponent field, and a fraction field. The fields represent floating-point numbers in the following manner:

Floating-Point Number = <sign> 1.<fraction field> x 2(<exponent field> - bias)

Sign bit field

The sign bit field is the most significant bit of the floating-point number. The sign bit is 0 for positive numbers and 1 for negative numbers.

Fraction field

The fraction field contains the fractional part of a normalized number. Normalized numbers are greater than or equal to 1 and less than 2. Since all normalized numbers are of the form 1.XXXXXXXX, the 1 becomes implicit and is not stored in memory. The bits in the fraction field are the bits to the right of the binary point, and they represent negative powers of 2. For example:

0.011 (binary) = $2^{-2} + 2^{-3} = 0.25 + 0.125 = 0.375$

Exponent field

The exponent field contains a biased exponent; that is, a constant bias is subtracted from the number in the exponent field to yield the actual exponent. (The bias makes negative exponents possible.)

If both the exponent field and the fraction field are zero, the floating-point number is zero.

NaN

A NaN (Not a Number) is a special value that is used when the result of an operation is undefined. For example, adding positive infinity to negative infinity results in a NaN.

FLOAT data type

The FLOAT data type is stored in the IEEE single-precision format which is 32 bits long. The most significant bit is the sign bit, the next 8 most significant bits are the exponent field, and the remaining 23 bits are the fraction field. The bias of the exponent is 127. The range of single-precision format values is from 1.18×10^{-38} to 3.4×10^{38} . The floating-point number is precise to 6 decimal digits.



- 0 000 0000 0 000 0000 0000 0000 0000 0000 = 0.0
- 0 011 1111 1 000 0000 0000 0000 0000 0000 = 1.0
- 1 011 1111 1 011 0000 0000 0000 0000 0000 = -1.375
- 1 111 1111 1 111 1111 1111 1111 1111 1111 = NaN

DOUBLE

The DOUBLE data type is stored in the IEEE double-precision format which is 64 bits long. The most significant bit is the sign bit, the next 11 most significant bits are the exponent field, and the remaining 52 bits are the fractional field. The bias of the exponent is 1023. The range of single precision format values is from 2.23×10^{-308} to 1.8×10^{308} . The floating-point number is precise to 15 decimal digits.

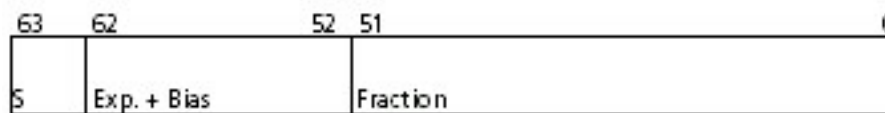

- 0 000 0000 0000 0000 0000 ... 0000 0000 0000 = 0.0
- 0 011 1111 1111 0000 0000 ... 0000 0000 0000 = 1.0
- 1 011 1111 1110 0110 0000 ... 0000 0000 0000 = -0.6875
- 1 111 1111 1111 1111 1111 ... 1111 1111 1111 = NaN

Specifications

- Performance specifications
- Positioning performance
- Hardware
- Antenna phase center offsets
- Pinout information

Performance specifications

Measurements

Measure points in harsh GNSS environments with greater accuracy, reliability, and productivity than ever before with Trimble ProPoint™ GNSS technology

Increased measurement productivity and traceability with Trimble SurePoint electronic level bubble and tilt compensation

Worldwide centimeter-level positioning using Trimble CenterPoint RTX satellite or internet delivered correction services

Reduced downtime due to loss of radio signal or cellular connectivity with Trimble xFill technology

Dual Trimble Custom GNSS ASIC with 672 channels

Future-proof your investment with Trimble 360 GNSS tracking

Satellite signals tracked simultaneously

- GPS: L1C/A, L1C, L2C, L2E, L5
- GLONASS: L1C/A, L1P, L2C/A, L2P, L3
- SBAS: L1C/A, L5 (For SBAS satellites that support L5)
- Galileo: E1, E5A, E5B, E5 AltBOC, E6¹
- BeiDou: B1, B1C, B2, B2A, B3
- QZSS: L1C/A, L1-SAIF, L1C, L2C, L5
- NavIC (IRNSS): L5

Trimble CenterPoint RTX, OmniSTAR HP, XP, G2, VBS correction services

WAAS, EGNOS, GAGAN, MSAS

Reliable tracking in challenging environments with advanced Low Noise Amplifier (LNA) with 50 dB signal gain to reduce signal tracking effects caused by high power out-of-band transmitters

Additional iridium filtering above 1616 MHz allows antenna to be used as close as 20 m of iridium transmitter

Additional Japanese filtering below 1510 MHz allows antenna to be used as close as 100 m of Japanese LTE cell tower

Digital Signal Processor (DSP) techniques to detect and recover from spoofed GNSS

 signals

 Advanced Receiver Autonomous Integrity Monitoring (RAIM) algorithm to detect and reject problem satellite measurements to improve position quality

 Improved protection from erroneous ephemeris data

 Positioning Rates 1 Hz, 2 Hz, 5 Hz, 10 Hz, and 20 Hz

1. The current capability in the receivers is based on publicly available information. As such, Trimble cannot guarantee that these receivers will be fully compatible with a future generation of Galileo satellites or signals.

Positioning performance

NOTE – Precision and reliability may be subject to anomalies due to multipath, obstructions, satellite geometry, and atmospheric conditions. The specifications stated recommend the use of stable mounts in an open sky view, EMI and multipath clean environment, optimal GNSS constellation configurations, along with the use of survey practices that are generally accepted for performing the highest-order surveys for the applicable application including occupation times appropriate for baseline length. Baselines longer than 30 km require precise ephemeris and occupations up to 24 hours may be required to achieve the high precision static specification.

Code differential GNSS positioning

Horizontal	0.25 m + 1 ppm RMS
Vertical	0.50 m + 1 ppm RMS
SBAS differential	typically <5 m 3DRMS

NOTE – SBAS differential performance depends on WAAS/EGNOS system performance.

Static GNSS surveying

High Precision Static	Horizontal	3 mm + 0.1 ppm RMS
	Vertical	3.5 mm + 0.4 ppm RMS

Static and Fast Static

Horizontal	3 mm + 0.5 ppm RMS
Vertical	5 mm + 0.5 ppm RMS

Real Time Kinematic surveying

Single Baseline <30 km	Horizontal	8 mm + 1 ppm RMS
	Vertical	15 mm + 1 ppm RMS
Network RTK	Horizontal	8 mm + 0.5 ppm RMS
	Vertical	15 mm + 0.5 ppm RMS
RTK start-up time for specified precisions		2 to 8 seconds

NOTE – Network RTK PPM values are referenced to the closest physical base station. RTK precision times may be affected by atmospheric conditions, signal multipath, obstructions and satellite geometry. Positioning reliability is continuously monitored to ensure highest quality.

Trimble RTX Technology (Satellite and Cellular/Internet (IP))

CenterPoint RTX	Horizontal	2 cm RMS
	Vertical	5 cm RMS
RTX convergence time for specified precisions - Worldwide		< 15 minutes
RTX QuickStart convergence time for specified precisions		< 1 minute
RTX convergence time for specified precisions in select regions (Trimble RTX Fast Regions)		< 1 minute

NOTE – RMS performance based on repeatable in field measurements. Achievable accuracy and initialization time may vary based on type and capability of receiver and antenna, user's geographic location and atmospheric activity, scintillation levels, GNSS constellation health and availability and level of multipath including obstructions such as large trees and buildings.

Trimble xFill

Horizontal	RTK + 10 mm/minute RMS
Vertical	RTK + 20 mm/minute RMS

NOTE – Accuracies are dependent on GNSS satellite availability. xFill positioning without a Trimble CenterPoint RTX subscription ends after 5 minutes of radio downtime. xFill positioning with a CenterPoint RTX subscription will continue beyond 5 minutes providing the Trimble RTX solution has converged, with typical precisions not exceeding 6 cm horizontal, 14 cm vertical or 3 cm horizontal, 7 cm vertical in Trimble RTX Fast regions. xFill is not available in all regions, check with

your local sales representative for more information.

NOTE – RTK refers to the last reported precision before the correction source was lost and xFill started.

Hardware

Physical

Dimensions (diameter x height)	11.9 cm x 13.6 cm (4.6 in x 5.4 in)
Weight	1.12 kg (2.49 lb) with internal battery, internal radio with UHF antenna 3.95 kg (8.71 lb) items above plus range pole, TSC7 & bracket
Temperature	
Operating	-40 °C to +65 °C (-40 °F to +149 °F)
Storage	-40 °C to +75 °C (-40 °F to +167 °F)
	NOTE – Receiver will operate normally to -40 °C, internal batteries are rated to -20 °C.
Humidity	100%, condensing
Ingress protection	IP67 dustproof, protected from temporary immersion to depth of 1 m (3.28 ft)
Shock and vibration	Tested and meets the following environmental standards:
Shock	Non-operating: Designed to survive a 2 m (6.6 ft) pole drop onto concrete. Operating: to 40 G, 10 msec, sawtooth
Vibration	MIL-STD-810F, FIG.514.5C-1

Electrical

Voltage	11 to 24 VDC external power input with over-voltage protection on Port 1 and Port 2 (7-pin Lemo)
Battery	Rechargeable, removable 7.4 V, 3.7 Ah Lithium-Ion smart battery with LED status indicators

Power consumption	4.2 Watts in RTK rover mode with internal radio	
	<i>NOTE – Tracking GPS, GLONASS and SBAS satellites.</i>	
	Operating times on internal battery:	
	450 MHz receive only option	6.5 hours
	450 MHz receive/transmit option (0.5 watts)	6 hours
	450 MHz receive/transmit option (2.0 watts)	5.5 hours
	Cellular receive option	6.5 hours

NOTE – Operating times vary with temperature and wireless data rate. When using a receiver and internal radio in transmit mode, Trimble recommends using an external 6 Ah or higher battery.

GNSS antenna

Ultra compact Trimble Zephyr technology

Type	Dual 4 Point Feed
Polarization	Right-hand circular
Axial Ratio	2 dB at zenith
Low Noise Amplifier	Advanced multi-stage tuned for all GNSS
Signal filtering	Iridium and Japanese LTE filtering

Integrated level sensor

Accuracy	+/- 0.01° horizontal axis
Resolution	0.014°
Range	+/- 20° from horizontal
Maximum Update Rate	50 Hz

Communications and data storage

- Serial – 3-wire serial (7-pin Lemo).
- USB v2.0 – Supports data download and high speed communications.
- Radio modem – Integrated, sealed, 450 MHz wide band receiver/transmitter with Frequency Range of 403 – 473 MHz, support of Trimble, Pacific Crest, and SATEL radio

protocols:

- Transmit power of 2 Watts maximum
- Range: 3-5 km typical /10 km optimal. Varies with terrain and operating conditions.
- Cellular – Integrated, 3.5 G modem, HSDPA 7.2 Mbps (download), GPRS multi-slot class 12, EDGE multi-slot class 12, Penta-band UMTS/HSDPA (WCDMA/FDD) 800/850/900/1900/2100 MHz, Quad-band EGSM 850/900/1800/1900 MHz, GSM CSD, 3GPP LTE
- Bluetooth – Fully integrated, fully sealed 2.4 GHz communications port.
 - NOTE – Bluetooth type approvals are country-specific.*
- Wi-Fi – 802.11 b,g, access point and client mode, WPA/WPA2/WEP64/WEP128 encryption.
- External communication devices for corrections supported on: Serial, USB, Ethernet, and Bluetooth ports.
- Data storage – 6 GB internal memory: over ten years of raw observables (approx. 1.4 MB / Day), based on recording every 15 seconds from an average of 14 satellites.
- Data format:
 - CMR+, CMRx, RTCM 2.1, RTCM 2.3, RTCM 3.0, RTCM 3.1, RTCM 3.2 Input and Output.
 - 24 NMEA outputs, GSOF, 1PPS, RT17 and RT27 outputs

Antenna phase center offsets

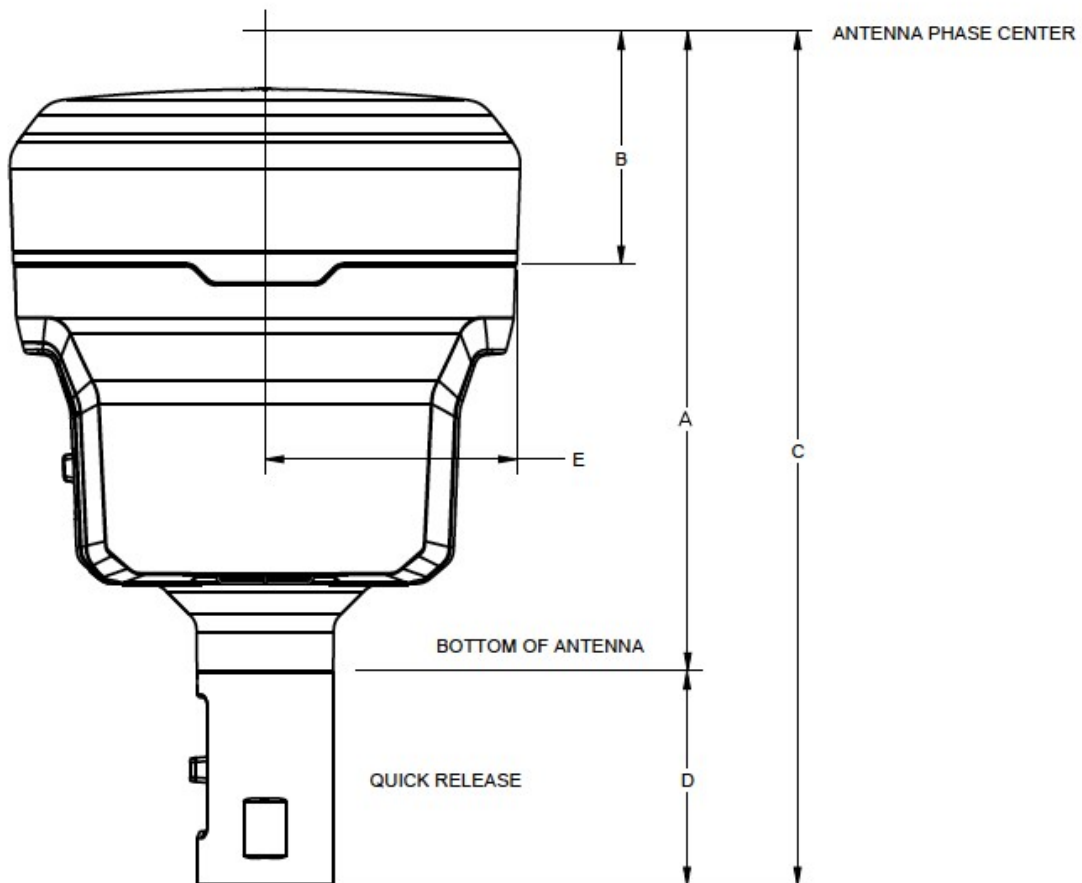

	Dimensions		Description
A	0.4892 FT	0.1491 M	Bottom of Antenna to Nominal Phase Center
B	0.1790 FT	0.0546 M	Bottom of Bumper to Nominal Phase Center
C	0.6532 FT	0.1991 M	Bottom of Quick Release to Nominal Phase Center
D	0.1640 FT	0.0500 M	Quick Release Height
E	0.1915 FT	0.0584 M	Radial: Centerline of Antenna to Bottom Outer Edge of Bumper

Pinout information

Port 1 is a 7-pin 0-shell Lemo connector that supports RS-232 communications and external power input. Port 1 has no power outputs.

Port 2 is a 7-pin 0-shell Lemo connector that allows for USB 2.0 communications and external power input.

PIN OUTS
VIEW LOOKING AT CONNECTORS
ON R10 RECEIVER

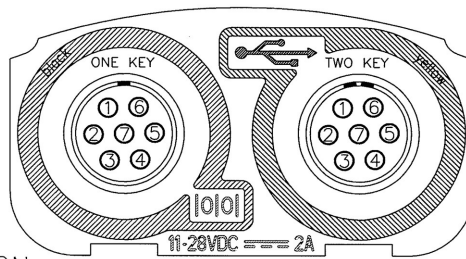

PIN	FUNCTION
1	GROUND (-)
2	GROUND (-)
3	TX DATA (OUTPUT)
4	RTS (OUTPUT)
5	CTS (INPUT)
6	POWER (+)
7	RX DATA (INPUT)



PIN	FUNCTION
1	GROUND (-)
2	GROUND (-)
3	VBUS
4	D-
5	D+
6	POWER (+)
7	ID

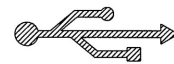

Glossary

1PPS	Pulse-per-second. Used in hardware timing. A pulse is generated in conjunction with a time stamp. This defines the instant when the time stamp is applicable.
Almanac	<p>A file that contains orbit information on all the satellites, clock corrections, and atmospheric delay parameters. The almanac is transmitted by a GNSS satellite to a GNSS receiver, where it facilitates rapid acquisition of GNSS signals when you start collecting data, or when you have lost track of satellites and are trying to regain GNSS signals.</p> <p>The orbit information is a subset of the ephemeris/ephemerides data.</p>
Base station	Also called <i>reference station</i> . In construction, a base station is a receiver placed at a known point on a jobsite that tracks the same satellites as an RTK rover, and provides a real-time differential correction message stream through radio to the rover, to obtain centimeter level positions on a continuous real-time basis. A base station can also be a part of a virtual reference station network, or a location at which GNSS observations are collected over a period of time, for subsequent postprocessing to obtain the most accurate position for the location.
BeiDou	<p>The BeiDou Navigation Satellite System (also known as BDS) is a Chinese satellite navigation system.</p> <p>The first BeiDou system (known as BeiDou-1), consists of four satellites and has limited coverage and applications. It has been offering navigation services mainly for customers in China and from neighboring regions since 2000.</p> <p>The second generation of the system (known as BeiDou-2) consists of satellites in a combination of geostationary, inclined geosynchronous, and medium earth orbit configurations. It became operational with coverage of China in December 2011. However, the complete Interface Control Document (which specifies the satellite messages) was not released until</p>

	<p>December 2012. BeiDou-2 is a regional navigation service which offers services to customers in the Asia-Pacific region.</p> <p>The third generation of the system (known as Beidou-3) consists of 3 geostationary satellites, 3 geosynchronous, and 24 Medium Earth orbit (MEO) satellites. As of 2018, 15 Beidou-3 satellites have been launched. The Chinese government plans on having Beidou-3 fully operational in 2020.</p>
Broadcast server	An Internet server that manages authentication and password control for a network of VRS servers, and relays VRS corrections from the VRS server that you select.
Carrier	A radio wave having at least one characteristic (such as frequency, amplitude, or phase) that can be varied from a known reference value by modulation.
Carrier frequency	The frequency of the unmodulated fundamental output of a radio transmitter. The GPS L1 carrier frequency is 1575.42 MHz.
Carrier phase	Is the cumulative phase count of the GPS or GLONASS carrier signal at a given time.
Cellular modems	A wireless adapter that connects a laptop computer to a cellular phone system for data transfer. Cellular modems, which contain their own antennas, plug into a PC Card slot or into the USB port of the computer and are available for a variety of wireless data services such as GPRS.
Clock steering	When enabled, the receiver clock is steered to GPS system time rather than periodically introducing 1 ms steps and constraining the clock to ± 0.5 ms. Disabled by default; this setting does not affect performance.
CMR/CMR+	Compact Measurement Record. A real-time message format developed by Trimble for broadcasting corrections to other Trimble receivers. CMR is a more efficient alternative to RTCM .
CMRx	A real-time message format developed by Trimble for transmitting more satellite corrections resulting from more satellite signals, more constellations, and more satellites. Its compactness means more repeaters can be used on a site.
CMR ID	A unique identifier for the CMR message. It can be any value between 0 through 31.

CMR input filter	Shows whether or not CMR corrections are being used from a specific base station.
Code Diff	Code differential solution. Typically a single-frequency solution.
Constrained height	An external height constraint for the antenna position. The receiver will produce a height value within the constraints provided by the external application.
Covariance	A statistical measure of the variance of two random variables that are observed or measured in the same mean time period. This measure is equal to the product of the deviations of corresponding values of the two variables from their respective means.
Datum	<p>Also called <i>geodetic datum</i>. A mathematical model designed to best fit the geoid, defined by the relationship between an ellipsoid and, a point on the topographic surface, established as the origin of the datum. World geodetic datums are typically defined by the size and shape of an ellipsoid and the relationship between the center of the ellipsoid and the center of the earth.</p> <p>Because the earth is not a perfect ellipsoid, any single datum will provide a better model in some locations than in others. Therefore, various datums have been established to suit particular regions.</p> <p>For example, maps in Europe are often based on the European datum of 1950 (ED-50). Maps in the United States are often based on the North American datum of 1927 (NAD-27) or 1983 (NAD-83).</p> <p>All GPS coordinates are based on the WGS-84 datum surface.</p>
Deep discharge	Withdrawal of all electrical energy to the end-point voltage before the cell or battery is recharged.
DGPS	See real-time differential GPS .
Differential correction	Differential correction is the process of correcting GNSS data collected on a rover with data collected simultaneously at a base station . Because the base station is on a known location, any errors in data collected at the base station can be measured, and the necessary corrections applied to the rover data.

	Differential correction can be done in real-time, or after the data is collected by postprocessing .
Differential GPS	See real-time differential GPS .
DOP	Dilution of Precision. A measure of the quality of GNSS positions, based on the geometry of the satellites used to compute the positions. When satellites are widely spaced relative to each other, the DOP value is lower, and position precision is greater. When satellites are close together in the sky, the DOP is higher and GNSS positions may contain a greater level of error. PDOP (Position DOP) indicates the three-dimensional geometry of the satellites. Other DOP values include HDOP (Horizontal DOP) and VDOP (Vertical DOP), which indicate the precision of horizontal measurements (latitude and longitude) and vertical measurements respectively. PDOP is related to HDOP and VDOP as follows: $PDOP^2 = HDOP^2 + VDOP^2$.
Dual-frequency GPS	A type of receiver that uses both L1 and L2 signals from GPS satellites. A dual-frequency receiver can compute more precise position fixes over longer distances and under more adverse conditions because it compensates for ionospheric delays.
EGNOS	European Geostationary Navigation Overlay Service. A Satellite-Based Augmentation System (SBAS) that provides a free-to-air differential correction service for GNSS. EGNOS is the European equivalent of WAAS , which is available in the United States.
Elevation	The vertical distance from a geoid such as EGM96 to the antenna phase center. The geoid is sometimes referred to as Mean Sea Level.
Elevation mask	The angle below which the receiver will not track satellites. Normally set to 10 degrees to avoid interference problems caused by buildings and trees, atmospheric issues, and multipath errors.
Ellipsoid	An ellipsoid is the three-dimensional shape that is used as the basis for mathematically modeling the earth's surface. The ellipsoid is defined by the lengths of the minor and major axes. The earth's minor axis is the polar axis and the major axis is the

	equatorial axis.
EHT	Height above ellipsoid.
Ephemeris/ephemerides	A list of predicted (accurate) positions or locations of satellites as a function of time. A set of numerical parameters that can be used to determine a satellite's position. Available as broadcast ephemeris or as postprocessed precise ephemeris.
Epoch	The measurement interval of a GNSS receiver. The epoch varies according to the measurement type: for real-time measurement it is set at one second; for postprocessed measurement it can be set to a rate of between one second and one minute. For example, if data is measured every 15 seconds, loading data using 30-second epochs means loading every alternate measurement.
Feature	A feature is a physical object or event that has a location in the real world, which you want to collect position and/or descriptive information (attributes) about. Features can be classified as surface or non-surface features, and again as points, lines/break lines, or boundaries/areas.
Firmware	The program inside the receiver that controls receiver operations and hardware.
GAGAN	GPS Aided Geo Augmented Navigation. A Satellite Based Augmentation System (SBAS) for the Indian Airspace.
Galileo	Galileo is a GNSS system built by the European Union and the European Space Agency. It is complimentary to GPS and GLONASS.
Geoid	The geoid is the equipotential surface that would coincide with the mean ocean surface of the Earth. For a small site this can be approximated as an inclined plane above the Ellipsoid.
GHT	Height above geoid.
GLONASS	Global Orbiting Navigation Satellite System. GLONASS is a Soviet space-based navigation system comparable to the American GPS system. The operational system consists of 21 operational and 3 non-operational satellites in 3 orbit planes.
GNSS	Global Navigation Satellite System.
GPS	Global Positioning System. GPS is a space-based satellite

	navigation system, owned by the United States government, consisting of multiple satellites in six orbit planes.
GSOF	General Serial Output Format. A Trimble proprietary message format.
HDOP	Horizontal Dilution of Precision. HDOP is a DOP value that indicates the precision of horizontal measurements. Other DOP values include VDOP (vertical DOP) and PDOP (Position DOP). Using a maximum HDOP is ideal for situations where vertical precision is not particularly important, and your position yield would be decreased by the vertical component of the PDOP (for example, if you are collecting data under canopy).
Height	The vertical distance above the ellipsoid. The classic ellipsoid used in GPS is WGS-84.
IBSS	Internet Base Station Service. This Trimble service makes the setup of an Internet-capable receiver as simple as possible. The base station can be connected to the Internet (cable or wirelessly). To access the distribution server, the user enters a password into the receiver. To use the server, the user must have a Trimble Connected Community site license.
IRNSS	The Indian Regional Navigation Satellite System (IRNSS) with an operational name of NAVIC ("sailor" or "navigator" in Sanskrit, Hindi and many other Indian languages, which also stands for NAVigation with Indian Constellation) is an autonomous regional satellite navigation system that provides accurate real-time positioning and timing services
L1	The primary L-band carrier used by GPS and GLONASS satellites to transmit satellite data.
L2	The secondary L-band carrier used by GPS and GLONASS satellites to transmit satellite data.
L2C	A modernized code that allows significantly better ability to track the L2 frequency.
L5	The third L-band carrier used by GPS satellites to transmit satellite data. L5 will provide a higher power level than the other carriers. As a result, acquiring and tracking weak signals will be easier.

Mountpoint	Every single Ntrip Source needs a unique mountpoint on an Ntrip Caster. Before transmitting GNSS data to the Ntrip Caster, the Ntrip Server sends an assignment of the mountpoint.
MSAS	MTSAT Satellite-Based Augmentation System. A Satellite-Based Augmentation System (SBAS) that provides a free-to-air differential correction service for GNSS. MSAS is the Japanese equivalent of WAAS , which is available in the United States.
Multipath	Interference, similar to ghosts on an analog television screen that occurs when GNSS signals arrive at an antenna having traversed different paths. The signal traversing the longer path yields a larger pseudorange estimate and increases the error. Multiple paths can arise from reflections off the ground or off structures near the antenna.
NavIC (IRNSS)	Navigation with Indian Constellation. Previously the Indian Regional Navigation Satellite System. An autonomous regional satellite navigation system that covers India and surrounding areas.
NMEA	National Marine Electronics Association. NMEA 0183 defines the standard for interfacing marine electronic navigational devices. This standard defines a number of 'strings' referred to as NMEA strings that contain navigational details such as positions. Most Trimble GNSS receivers can output positions as NMEA strings.
Ntrip Protocol	Networked Transport of RTCM via Internet Protocol (Ntrip) is an application-level protocol that supports streaming Global Navigation Satellite System (GNSS) data over the Internet. Ntrip is a generic, stateless protocol based on the Hypertext Transfer Protocol (HTTP). The HTTP objects are extended to GNSS data streams.
Ntrip Caster	The Ntrip Caster is basically an HTTP server supporting a subset of HTTP request/response messages and adjusted to low-bandwidth streaming data. The Ntrip Caster accepts request messages on a single port from either the Ntrip Server or the Ntrip Client. Depending on these messages, the Ntrip Caster decides whether there is streaming data to receive or to send.

	<p>Trimble Ntrip Caster integrates the Ntrip Server and the Ntrip Caster. This port is used only to accept requests from Ntrip Clients.</p>
Ntrip Client	<p>An Ntrip Client will be accepted by and receive data from an Ntrip Caster, if the Ntrip Client sends the correct request message (TCP/UDP connection to the specified Ntrip Caster IP and listening port).</p>
Ntrip Server	<p>The Ntrip Server is used to transfer GNSS data of an Ntrip Source to the Ntrip Caster. An Ntrip Server in its simplest setup is a computer program running on a PC that sends correction data of an Ntrip Source (for example, as received through the serial communication port from a GNSS receiver) to the Ntrip Caster.</p> <p>The Ntrip Server - Ntrip Caster communication extends HTTP by additional message formats and status codes.</p>
Ntrip Source	<p>The Ntrip Sources provide continuous GNSS data (for example, RTCM-104 corrections) as streaming data. A single source represents GNSS data referring to a specific location. Source description parameters are compiled in the source-table.</p>
OmniSTAR	<p>The OmniSTAR HP/XP service allows the use of new generation dual-frequency receivers with the OmniSTAR service. The HP/XP service does not rely on local reference stations for its signal, but utilizes a global satellite monitoring network. Additionally, while most current dual-frequency GNSS systems are accurate to within a meter or so, OmniSTAR with XP is accurate in 3D to better than 30 cm.</p>
Orthometric elevation	<p>The Orthometric Elevation is the height above the geoid (often termed the height above the 'Mean Sea Level').</p>
PDOP	<p>Position Dilution of Precision. PDOP is a DOP value that indicates the precision of three-dimensional measurements. Other DOP values include VDOP (vertical DOP) and HDOP (Horizontal Dilution of Precision).</p> <p>Using a maximum PDOP value is ideal for situations where both vertical and horizontal precision are important.</p>
PoE	<p>Power over Ethernet. Provides DC power to the receiver using an Ethernet cable.</p>

Postprocessing	Postprocessing is the processing of satellite data after it is collected, in order to eliminate error. This involves using computer software to compare data from the rover with data collected at the base station.
QZSS	Quasi-Zenith Satellite System. A Japanese regional GNSS, eventually consisting of three geosynchronous satellites over Japan.
Real-time differential GPS	<p>Also known as <i>real-time differential correction</i> or <i>DGPS</i>. Real-time differential GPS is the process of correcting GPS data as you collect it. Corrections are calculated at a base station and then sent to the receiver through a radio link. As the rover receives the position it applies the corrections to give you a very accurate position in the field.</p> <p>Most real-time differential correction methods apply corrections to code phase positions.</p> <p>While DGPS is a generic term, its common interpretation is that it entails the use of single-frequency code phase data sent from a GNSS base station to a rover GNSS receiver to provide submeter position precision. The rover receiver can be at a long range (greater than 100 kms (62 miles)) from the base station.</p>
Rover	A rover is any mobile GNSS receiver that is used to collect or update data in the field, typically at an unknown location.
Roving mode	Roving mode applies to the use of a rover receiver to collect data, stakeout, or control machinery in real time using RTK techniques.
RTCM	Radio Technical Commission for Maritime Services. A commission established to define a differential data link for the real-time differential correction of roving GNSS receivers. There are three versions of RTCM correction messages. All Trimble GNSS receivers use Version 2 protocol for single-frequency DGPS type corrections. Carrier phase corrections are available on Version 2, or on the newer Version 3 RTCM protocol, which is available on certain Trimble dual-frequency receivers. The Version 3 RTCM protocol is more compact but is not as widely supported as Version 2.
RTK	Real-time kinematic. A real-time differential GPS method that

	uses carrier phase measurements for greater precision.
SBAS	Satellite-Based Augmentation System. SBAS is based on differential GPS, but applies to wide area (WAAS , EGNOS , MSAS , and GAGAN) networks of reference stations. Corrections and additional information are broadcast using geostationary satellites.
Signal-to-noise ratio	SNR. The signal strength of a satellite is a measure of the information content of the signal, relative to the signal's noise. The typical SNR of a satellite at 30° elevation is between 47 and 50 dB-Hz.
skyplot	The satellite skyplot confirms reception of a differentially corrected GNSS signal and displays the number of satellites tracked by the GNSS receiver, as well as their relative positions.
SNR	See signal-to-noise ratio .
Source-table	<p>The Ntrip Caster maintains a source-table containing information on available Ntrip Sources, networks of Ntrip Sources, and Ntrip Casters, to be sent to an Ntrip Client on request. Source-table records are dedicated to one of the following:</p> <ul style="list-style-type: none">• data STReams (record type STR)• CASters (record type CAS)• NETworks of data streams (record type NET) <p>All Ntrip Clients must be able to decode record type STR. Decoding types CAS and NET is an optional feature. All data fields in the source-table records are separated using the semicolon character.</p>
Triple frequency GPS	A type of receiver that uses three carrier phase measurements (L1 , L2 , and L5).
UTC	Universal Time Coordinated. A time standard based on local solar mean time at the Greenwich meridian.
xFill	Trimble xFill® is a service that extends RTK positioning for several minutes when the RTK correction stream is temporarily unavailable. The Trimble xFill service improves field productivity by reducing downtime waiting to re-establish RTK corrections in black spots. It can even expand productivity by

allowing short excursions into valleys and other locations where continuous correction messages were not previously possible. Proprietary Trimble xFill corrections are broadcast by satellite and are generally available globally where the GNSS constellations are also visible. It applies to any positioning task being performed with a single-base, Trimble Internet Base Station Service (IBSS), or VRS RTK correction source.

VRS

Virtual Reference Station. A VRS system consists of GNSS hardware, software, and communication links. It uses data from a network of [base stations](#) to provide corrections to each rover that are more accurate than corrections from a single base station.

To start using VRS corrections, the rover sends its position to the VRS server. The VRS server uses the base station data to model systematic errors (such as ionospheric noise) at the rover position. It then sends [RTCM](#), [CMRx](#), or [CMR+](#) correction messages back to the rover.

WAAS

Wide Area Augmentation System. WAAS was established by the Federal Aviation Administration (FAA) for flight and approach navigation for civil aviation. WAAS improves the accuracy and availability of the basic GNSS signals over its coverage area, which includes the continental United States and outlying parts of Canada and Mexico.

The WAAS system provides correction data for visible satellites. Corrections are computed from ground station observations and then uploaded to two geostationary satellites. This data is then broadcast on the L1 frequency, and is tracked using a channel on the GNSS receiver, exactly like a GNSS satellite.

Use WAAS when other correction sources are unavailable, to obtain greater accuracy than autonomous positions. For more information on WAAS, refer to the FAA website at <http://gps.faa.gov>.

The [EGNOS](#) service is the European equivalent and [MSAS](#) is the Japanese equivalent of WAAS.

WGS-84

World Geodetic System 1984. Since January 1987, WGS-84 has superseded WGS-72 as the [datum](#) used by GPS.

The WGS-84 datum is based on the [ellipsoid](#) of the same name.